

**Fixed Station
Upgrades/Developments**

N94-15601

MATERA LASER RANGING OBSERVATORY (MLRO); AN OVERVIEW

**Thomas Varghese, Winfield Decker, Henry Crooks
Allied-Signal Aerospace Company
Bendix/CDSLR Network
Seabrook, Maryland 20706
U.S.A.**

**Giuseppe Bianco
Agenzia Spaziale Italiana/Centro di Geodesia Spaziale
Matera, Italy**

Abstract:

The Agenzia Spaziale Italiana (ASI) is currently under negotiation with the Bendix Field Engineering Corporation (BFEC) of the Allied Signal Aerospace Company (ASAC) to build a state-of-the-art laser ranging observatory for the Centro di Geodesia Spaziale, in Matera, Italy. The contract calls for the delivery of a system based on a 1.5 meter afocal Cassegrain astronomical quality telescope with multiple ports to support a variety of experiments for the future, with primary emphasis on laser ranging. Three focal planes, viz. Cassegrain, Coude, and Nasmyth will be available for these experiments. The open-telescope system will be protected from dust and turbulence using a specialized dome which will be part of the building facilities to be provided by ASI. The fixed observatory facility will be partitioned into four areas for locating the following: laser, transmit/receive optics, telescope/dome enclosure, and the operations console. The optical tables and mount rest on a common concrete pad for added mechanical stability. Provisions will be in place for minimizing the effects of EMI, for obtaining maximum cleanliness for high power laser and transmit optics, and for providing an ergonomic environment fitting to a state-of-the-art multipurpose laboratory.

The system is currently designed to be highly modular and adaptable for scaling or changes in technology. It is conceived to be a highly automated system with superior performance specifications to any currently operational system. Provisions are also made to adapt and accommodate changes that are of significance during the course of design and integration.

MLRO : An Overview

Objective: Build a state-of-the-art, multi-purpose, laser ranging observatory in Matera, Italy

General Features

- Day and night automated ranging capability on all CCR-equipped satellites (> 400 km) and the moon
- Application of state-of-the-art technology in all sub-systems
- Real time calibration and interleaved multi-satellite tracking
- Multicolor ranging capability
- Advanced computing environment and data analysis tools
- Computerized documentation, with features such as relational database, expert system and hypermedia text

System Specifications

- LAGEOS ranging :
 - Single shot precision : ~5 mm
 - Normal point precision : <1 mm
- Low orbit satellite (ERS-1, Starlette, etc.) :
 - Single shot precision : 3 - 5 mm
- Lunar ranging :
 - Single shot precision : ~1 cm
- Real time calibration/ground ranging :
 - Single shot precision : <=2 mm
- Range accuracy: Better than 2mm

MLRO : An Overview

Telescope

- Near diffraction limited afocal Cassegrain telescope with a 1.5 meter primary and a 10 centimeter secondary; combination of a tertiary mirror and coude optics for transmission/reception
- Broadband coating for maximum spectral response from UV to near-IR
- Maximum slew rate :
 - Azimuth axis : 20 degrees/second
 - Elevation axis : 5 degrees/second
- Multiport system for other experiments

Laser

- Diode pumped laser for injection seeding
- Regenerative amplification followed by power amplifiers
- Pulse duration : <125 psec
- Pulse energy (532 nm) : >200 mJ
- Repetition rate : ≥ 10 Hz
- Computer controlled beam divergence
- Modularity for energy scaling / multi-wavelength generation
- Laser firing stability : better than 20 nsec

MLRO : An Overview

Control System

- Software in high level languages
- Automatic recording of all operational parameters
- Automated star calibration, mount modelling
- Computer-assisted optical alignment and verification
- Distributed data acquisition, processing, and control
- Advanced computing/control environment
- Automated system/sub-system simulation and debugging

Transmit/Receive Electronics

- Detection : High Q.E, high speed MCP-PMT/APD
- Signal processing :
 - Speed : 1 - 5 GHz
 - Dynamic range : 20
 - Jitter : <10 psec
- Event timer :
 - Clock frequency : 200 - 1000 MHz
 - Verniers : 4 - 8
 - Time resolution : 1 - 2 psec
 - Accuracy : 5 - 10 psec
 - Jitter : 10 - 20 psec
- Clock : Cesium with disciplined oscillator
- Gating : Range gate adjustable from 10 nsec to 10 μ sec

MLRO : An Overview

Current Status (Sept 1992)

- ASI and Bendix proceeding with negotiation/finalization of contract
- Estimated contract start in December 1992
- MLRO delivery in 42 months

PERFORMANCE OF THE UPGRADED ORRORAL LASER RANGING SYSTEM

John McK. Luck
Orroral Geodetic Observatory
Australian Surveying and Land Information Group
Department of Administrative Services
PO Box 2, Belconnen ACT 2616, Australia

1. Upgrade Arrangements

An Agreement 'being in respect of a project to develop Laser and Control Systems Upgrade to Orroral Laser Ranging System' between Electro Optic Systems Pty.Ltd. (EOS) and The Industry Research and Development Board (IRDB) of the Commonwealth Department of Industry, Technology and Commerce was signed on 23 March 1990. On the same day, a corresponding 'Agreement for Collaborative Research and Development of Laser and Control Systems Upgrade to Orroral Laser Ranging System' between the Australian Surveying and Land Information Group (AUSLIG) of the Commonwealth Department of Administrative Services and EOS, was signed. Under these Agreements, the research and development costs were shared between the three parties according to a standard IRDB formula, with AUSLIG having the option to purchase the prototype for its residual value upon successful demonstration. IRDB involvement was directed towards fostering export-oriented Australian high-technology industry.

The old system was de-commissioned on 6 March 1991, although preparatory work such as moving the laser and installing the heads and capacitor banks necessary for conversion to Active-Active mode was completed prior to that date. LAGEOS I was acquired a month later, on 10 April, and AJISAI on 12 April 1991 in Orroral's first-ever attempt at a 'low' target. The following eight months were spent in debugging and refining the new system and preparing for the ill-fated attempt to measure the geodetic baseline between the Orroral Laser Ranging System (OLRS) and the Saudi Arabian Laser Ranging Observatory (SALRO) set up at the Canberra Deep Space Communications Complex, Tidbinbilla to complement terrestrial and GPS surveys and to link SLR at Orroral with VLBI at Tidbinbilla.

The upgraded OLRs was deemed by AUSLIG to be operational from 1 January 1992, and final payment to EOS for purchase of the residual prototype was made in June 1992. A contract for software maintenance and further development was awarded to EOS in November 1992.

2. System Prior to 1991

The original system was the Orroral Lunar Laser Ranger (LLR), lent to the Division of National Mapping (Natmap) in 1973 under a Memorandum of Understanding involving NASA, Smithsonian Astrophysical Observatory and US Air Force Geophysical Laboratory. It was upgraded to include ranging to artificial

satellites under a contract from NASA signed in 1981, the first returns from LAGEOS-I being acquired in mid 1984. Some verified returns from the moon were received in 1985, and ranging to ETALON I & II started in 1990. It was not really possible to expect results for two-way ranges less than 35 milliseconds, which is one of the main reasons for embarking on the upgrade being described here.

Note : Natmap was merged with another Commonwealth agency in August 1987 to form AUSLIG.

DOME : The 9 metre diameter hemispherical dome by Ash Domes of Plainfield,IL was installed atop the original cylindrical Observatory building in 1973. Its AC motors for rotation during observing were manually controlled by a Left-Off-Right lever.

TELESCOPE : 1.5 metre aperture Ritchey-Chretien reflecting telescope, optics by University of Arizona. The tailpiece at the Cassegrain focus carries an eyepiece mounted on an X-Y stage for star observations and to facilitate offset guiding for lunar ranging.

The telescope is used both for transmitting and for receiving. It is depicted in figure 1.

TELESCOPE MOUNT : The telescope tube is by Astro Mechanics of Austin,TX. The original equatorial mount was replaced in 1981-2 by an X-Y ("alt over alt") mount by Contraves, and a Coude Path and the Contraves MPACS drive and readout systems were added. The drive accuracy is better than 0.002 degrees and encoder resolution is 0.0001 degrees.

An interface/controller was built, and all interface drivers and control and mount modelling software were written, by Natmap.

COUDE PATH : The Coude path incorporates a Matching Assembly consisting of two lenses whose combined focal point coincides with the focal point of the telescope. These lenses are in the East bearing of the telescope's inner axis. The Coude path connects the telescope with the laser, transmitter and receiver assemblies which are mounted on Newport optical benches in environmentally stable rooms. A Times 5 Beam expander by Special Optics,NJ on the Coude bench expands the transmitted beam prior to injection to the telescope through mirrors in the North bearing.

TRANSMIT/RECEIVE ASSEMBLY (T/R) : A rotating aluminized mirror with two holes in it, co-rotating 'dogbone' holding two ND filters and CAMAC-controlled stepping motors constituted the T/R assembly purchased from McDonald Observatory,TX in 1983. Laser firing was triggered by optically sensed notches in the rim of the rotating mirror.

The mirror was replaced in 1987 by an 'Appler mirror' in which the holes were just glass left uncoated (glass-hole), and which permitted positive, unambiguous ranging to a ground target and,

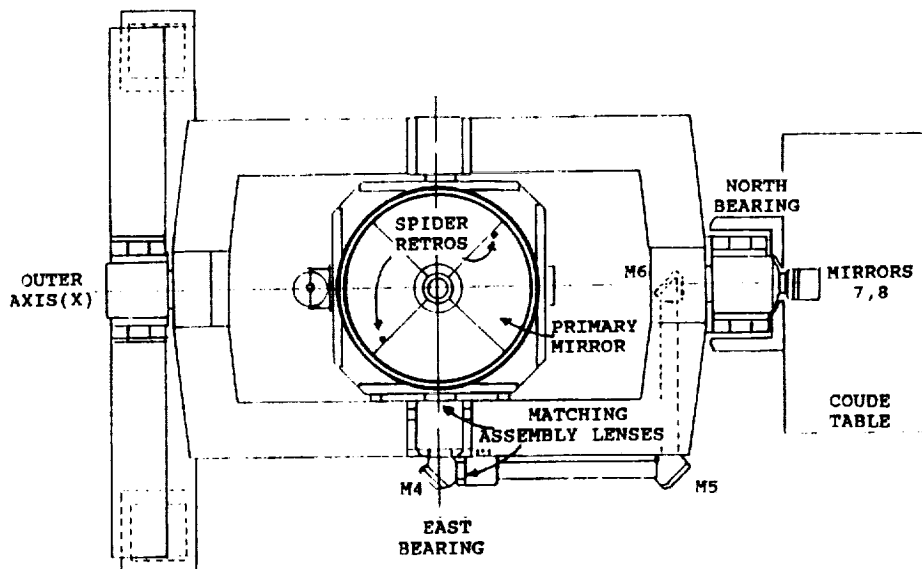
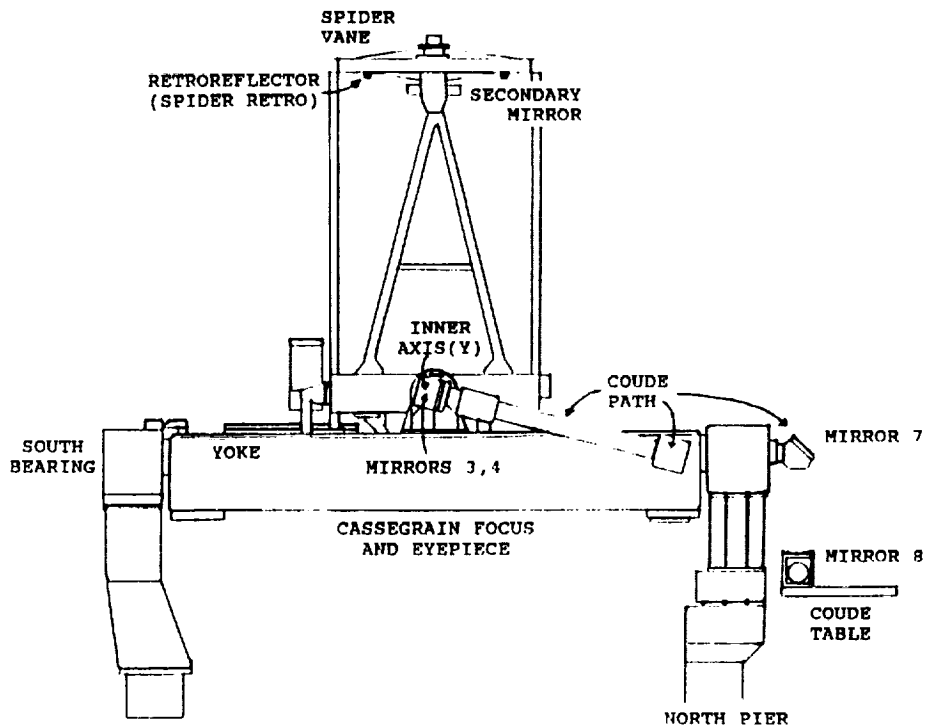

Figure 1: Orroral Laser Ranging System telescope - elevation and plan. (Derived from Contraves 'NLRs Telescope Manual'.)

for real-time internal calibrations, to geodetically accessible retro-reflectors placed on the spider vanes holding the telescope's secondary mirror.

The interface was controlled by the CAMAC bus system, and driver and high-level software was written by Natmap in collaboration with the University of Texas.

RECEIVER/DETECTOR : A light-tight box containing a turret of 5 pinholes (spatial filters), a turret with a 10 A° filter and a hole, focussing optics and detector mount was provided by McDonald Observatory. The detector mount was replaceable by an eyepiece for star alignments.

The detector was an RCA 31034A PMT until 1986, when the first of a series of ITT F4129f z-plate MCP PMTs was installed.

LASER : A Quantel YG 402 DP Nd:YAG laser frequency doubled to 532nm output wavelength was purchased as part of the 1981-3 upgrade. Its Q-switching and pulse slicing were accomplished passively, the mode locking being active/passive. Two amplifiers combined to produce in excess of 250mJ per pulse at ten pulses per second when needed. The pulse slicer was replaced by a Quantel solid-state slicer model SPS411 in 1987.

The laser was removed from its Quantel plate in the Coude room and relocated to an RF-shielded room one floor lower in the Observatory building in August 1990. Its components were bolted directly to a Newport optical table.

[The original Hughes 6943A^o ruby laser of the Orroral LLR prior to 1981 was bolted to the side of the telescope tube.]

LASER RANGING CONTROLLER (LRC) : This main interface/controller was designed and built by Natmap. It set windows and gates, controlled laser firing, and managed the epoch timing system.

EPOCH TIMING SYSTEM : Range measurements were accomplished by measuring the 'epoch' (time of day) of separate events, rather than depending upon a Time Interval Counter. The LRC time base was driven by a high spectral purity Oscilloquartz 2200 quartz frequency standard at 10MHz, and its clock synchronised at the start of each pass to an external Hewlett-Packard caesium beam frequency standard whose own clock was kept within 1 microsecond of UTC. The LRC Clock was used to time tag events to 100 nanosecond resolution.

Each laser shot produces at least three events to be time tagged: start diode pulse, internal calibration pulse from MCP/PMT, and one or more satellite returns from MCP/PMT (the quest to detect more than one 'satellite' return per shot was abandoned in the mid-1980's). The epoch timing system philosophy theoretically enables many events to be recorded per shot using identical equipment, limited only by instrumental reset/read times.

Two channels were used in practise to obtain fine resolution, one for start diode and one for MCP/PMT. Each comprised a separate channel of the Tennelec 454 Quad Constant Fraction Discriminator (CFD), a LeCroy 4202A Time to Digital Converter (TDC), and a pair of 8-channel LeCroy 2228A TDCs as verniers covering different 50ns sections. The 8 78-picosecond resolution channels of each 2228A were majority voted and meant to improve resolution to about 28ps. A standard calibration routine was run with each pass to relate the intrinsic 2228A delays to each other, with the scale factors being calibrated periodically against the 4202A TDCs.

All TDCs were read via the CAMAC bus system. Software for these tasks was written by Natmap.

RECEIVE ENERGY MONITOR : A LeCroy 2249A Analog-to-Digital Converter (ADC) ('charge digitiser') was installed on the MCP line in March 1990. It is controlled and read through the CAMAC bus system, and is gated by the 'AND' of the range gate window and of the discriminator output pulse delayed appropriately. Its input signal is amplified by a Stanford Research SR440.

OPERATING SOFTWARE : Apart from the lunar prediction package based on EULER and the satellite prediction package based on IRVINT, which were imported with the aid of Randall L. Ricklefs, all interface drivers, control and operations software, predictions, post-processing, mount modelling, simulation and test software was written by Natmap.

SYSTEM CALIBRATION : Until the end of 1987, the internal calibration pulse was picked off each transmitted laser pulse by a minutely reflecting 'feedback plate' in the T/R box and fed to the MCP/PMT through ND filters in the co-rotating 'dogbone'. The optical and electronic delays between this feedback plate and the epoch timing system were thus well calibrated, but the delay between the feedback plate and the system reference point was not well known, so it was not possible to assess system accuracy properly as it was found impossible to measure or even estimate the length of the convoluted Coude path (with its five refracting elements as added complications) to better than 10cm.

The advent of the 'Appler mirror' in 1987 made it possible to range to the 'Spider Retros' simultaneously with distant targets. The effective reflection points of the retro-reflectors were related to the instrumental reference point and external survey marks early in 1988 with 3mm accuracy by precise survey, enabling accurate correction constants to be calculated.

A ground target was installed at a distance of 1.1km across a valley in November 1987, and surveyed in along with 'Spider Retros'. A session of ranging to this target accompanied each LAGEOS-I pass, and provided a check on the accuracy of the correction constants referred to above. It is also invaluable for assessing such things as the effect of signal strength on range accuracy and the actual precision obtainable at any given time.

3. Elements of the Upgrade

DOME : Automated rotation was provided through hardware and interface controllers. Two DC variable-speed motors were installed in 1991 and new variable-speed controller, interface and software are now under development.

TELESCOPE and COUDE PATH : Not affected by the upgrade.

TELESCOPE DRIVE : A new interface/controller for the MPACS, and corresponding interface driver and high-level software, were provided, as were two new handpaddles with their interface, controller and driver.

TRANSMIT/RECEIVE ASSEMBLY : A completely new box was provided (figures 2,3). The T/R mirror has two genuine holes, and is connected to the co-rotating 'dogbone' by a shaft incorporating a clutch unit. Rotation rates up to 20 revs/second are possible, and are controlled directly from the MRCS. Laser firing is triggered by notches on the T/R mirror rim as before. Laser fire commands may be inhibited through a 'divide by' facility so that only every first, second, third or fourth notch actually causes a shot.

A minutely-reflecting wedged feedback plate (FBP) directs part of the transmitted pulses to targets on the Coude Table for the optical calibration of the timing system and, optionally, for a real-time internal calibration target ('Table Target'). The wedge also reflects a small part of return pulses through ND filters in the 'dogbone' to the detector; this facility is routinely used for the spider retro and ground target returns, the bulk of whose energy passes back through the T/R hole and is lost. Such returns therefore traverse a different path inside the T/R box than do satellite returns which take 1.644ns longer.

An electrically controlled PLZT optical attenuator is placed between the feedback wedge and the 'dogbone' to aid in matching calibration and ground target signal strengths to satellite return signal strengths. A special circuit ('wobulator') can sweep through the voltage range with 3 second period to give varying energies when adjusting discriminator walk.

RECEIVER/DETECTOR : A new Receiver Box (figures 2,4) contains a new 4-pinhole turret, separate ports for MCP mounting (with 10A⁰ filter built in) and eyepiece/RCA PMT mounting, a flip mirror to switch between ports, a flip mirror to access a CCD camera, a LED pulser to aid MCP characterisation, and new focussing optics. The flip mirrors can be software controlled via the MRCS.

To date, only ITT F4129f MCPs have been used, while the CCD camera and LED Pulser have not been used at all.

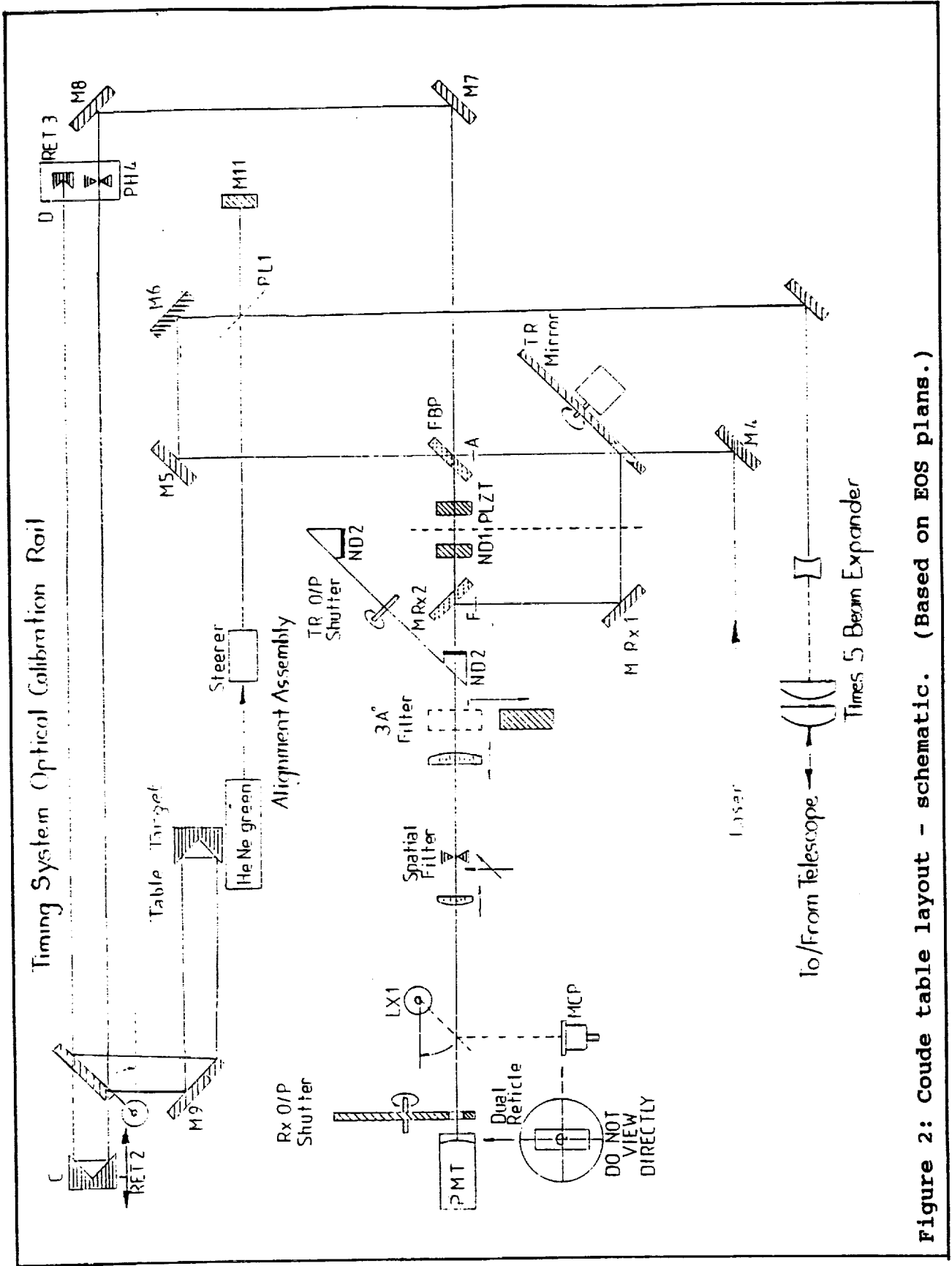

Figure 2: Coude table layout - schematic. (Based on EOS plans.)

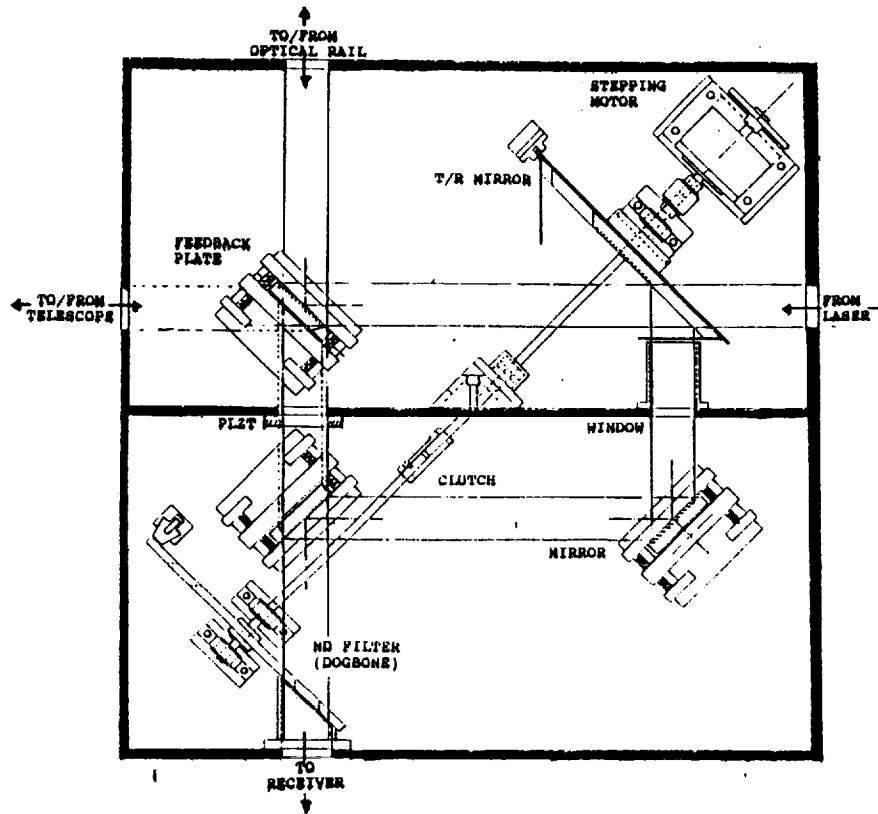

Figure 3: EOS Transmit/Receive assembly. (From EOS drawings.)

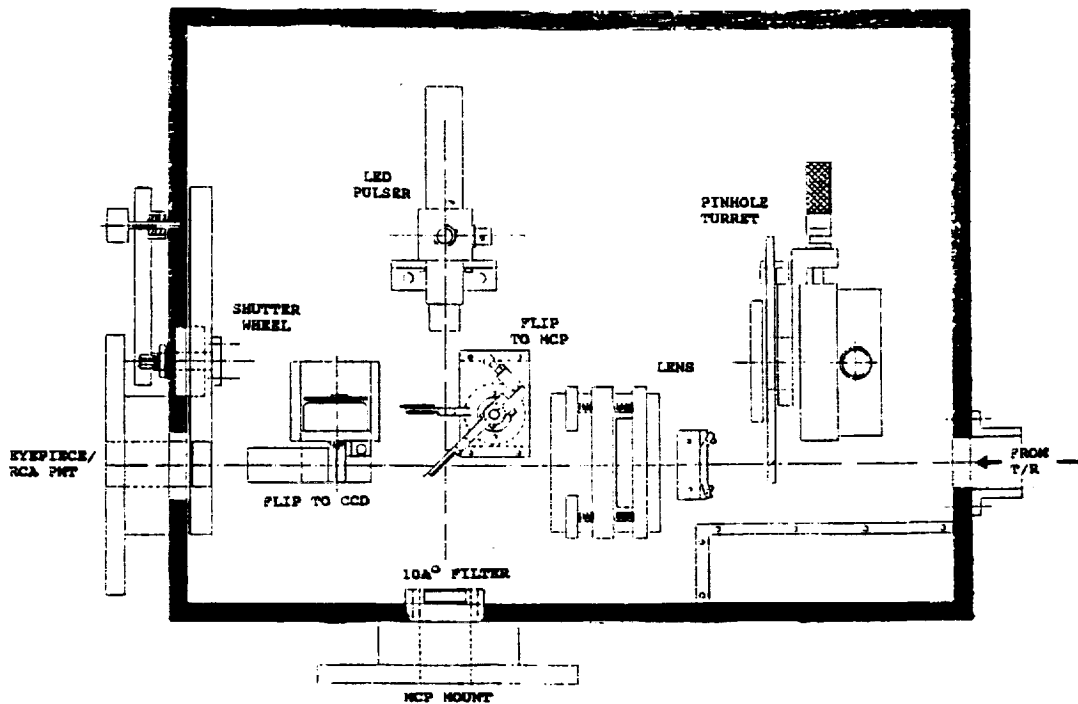

Figure 4: EOS Receiver assembly. (From EOS drawings.)

LASER : The oscillator was converted to Active Q-switching, Active mode-locking to a design by the Centre for Laser Physics of The Australian National University licenced to and developed by EOS. The SPS411 is also connected to the Active-Active circuitry to give positive pulse selection.

It was found necessary in 1990 to replace the laser heads with high-efficiency heads, and the capacitor banks with new units having simmer circuits. This work was supported by IRDB and completed in January 1991 with the installation of a CB632 and two CB631 units, and SF606-4, SF611-07 and SF611-09 heads, all made by Continuum. Later, a Continuum MV 70 RF generator for the Acousto Optic Modulator was also purchased, modified and installed, and other components have needed replacement.

The Upgrade Specifications required a third amplifier, or alternatively, the first amplifier would be double-passed through a spatial filter to keep the beam clean. Neither option has been invoked, yet the laser has achieved its overall goal of 250mJ per shot at 532nm when everything is working properly.

MASTER RANGING CONTROL SYSTEM (MRCS) : Replaced the LRC. It is based on EPLD chips, and sets windows and gates, controls T/R rotation and laser firing, manages all clock and epoch timing functions, and contains a full range of test and simulation facilities. The MRCS communicates extensively with the Hewlett Packard A900 1000-series minicomputer as shown in figure 5.

50 MHZ MULTIPLIER : The MRCS operates at 50MHz, so a box was provided to multiply up the 10 MHz output from the Oscilloquartz 2200 crystal.

EPOCH TIMING SYSTEM : The basic philosophy of 'epoch' event timing has been retained, and is accomplished by the MRCS Clock down to 20ns with EOS-modified LeCroy 2229A TDC verniers providing fine resolution. The intermediate 4202A TDC units are no longer necessary, and only one 2229A TDC is needed on each of the start diode and MCP lines. Each of the 8 channels of a 2229A TDC has a resolution of 25ps (nominal), the average giving 10ps (typical) resolution and precision.

The scale units (ns/count) of the verniers can be calibrated in three ways:

- . Programmable delay lines within the MRCS;
- . LeCroy 4202A TDC verniers, assumed accurate;
- . Optical delay line. In a pseudo-ranging operation, part of a transmitted laser pulse is reflected from the feedback wedge in the T/R Assembly and directed to a retroreflector which slides along a calibrated optical rail, thence back through the wedge to the MCP (see figure 2). The change in TDC reading is then related to change in retroreflector position.

The average offset of each vernier with respect to the first vernier is calibrated daily by injecting a sequence of simulated laser pulses generated within the MRCS into all the verniers.

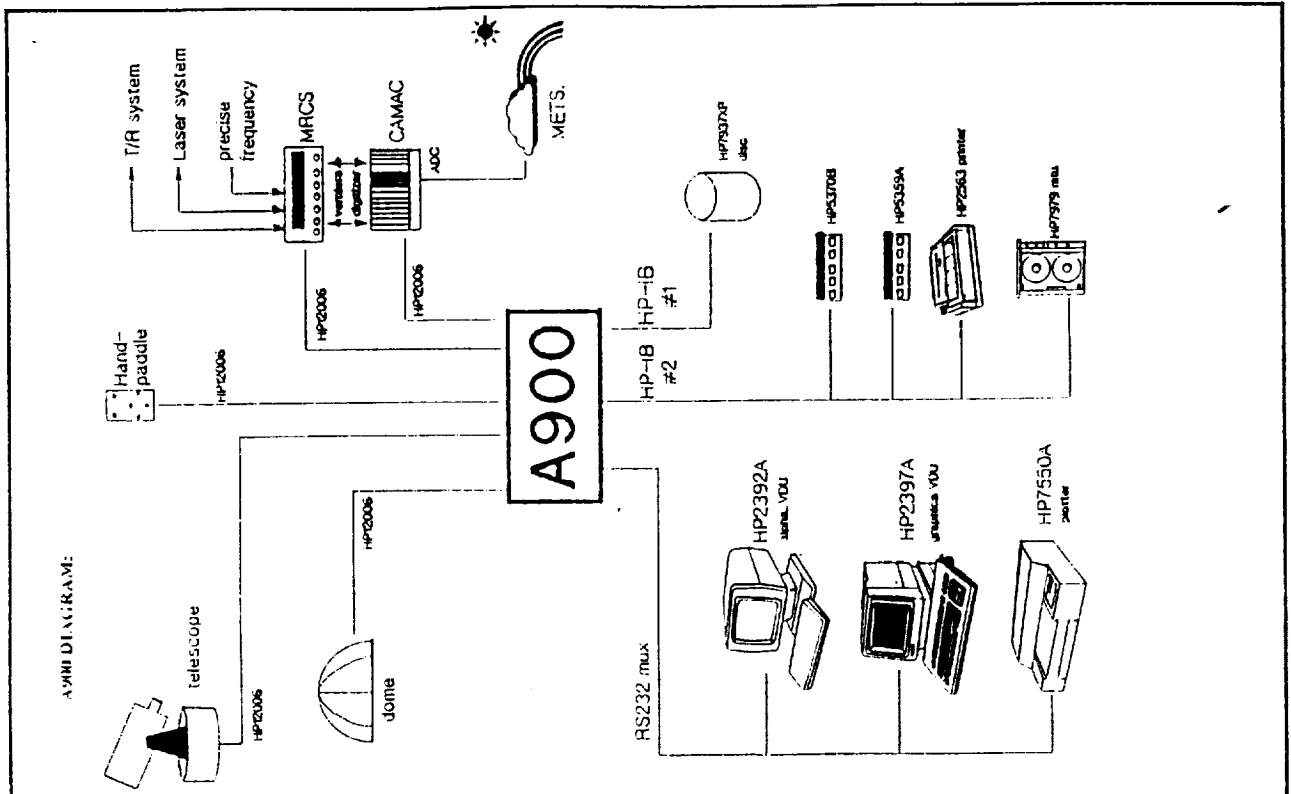

Figure 5: EOS Laser Ranging System. (EOS Operations Manual, V2.0)

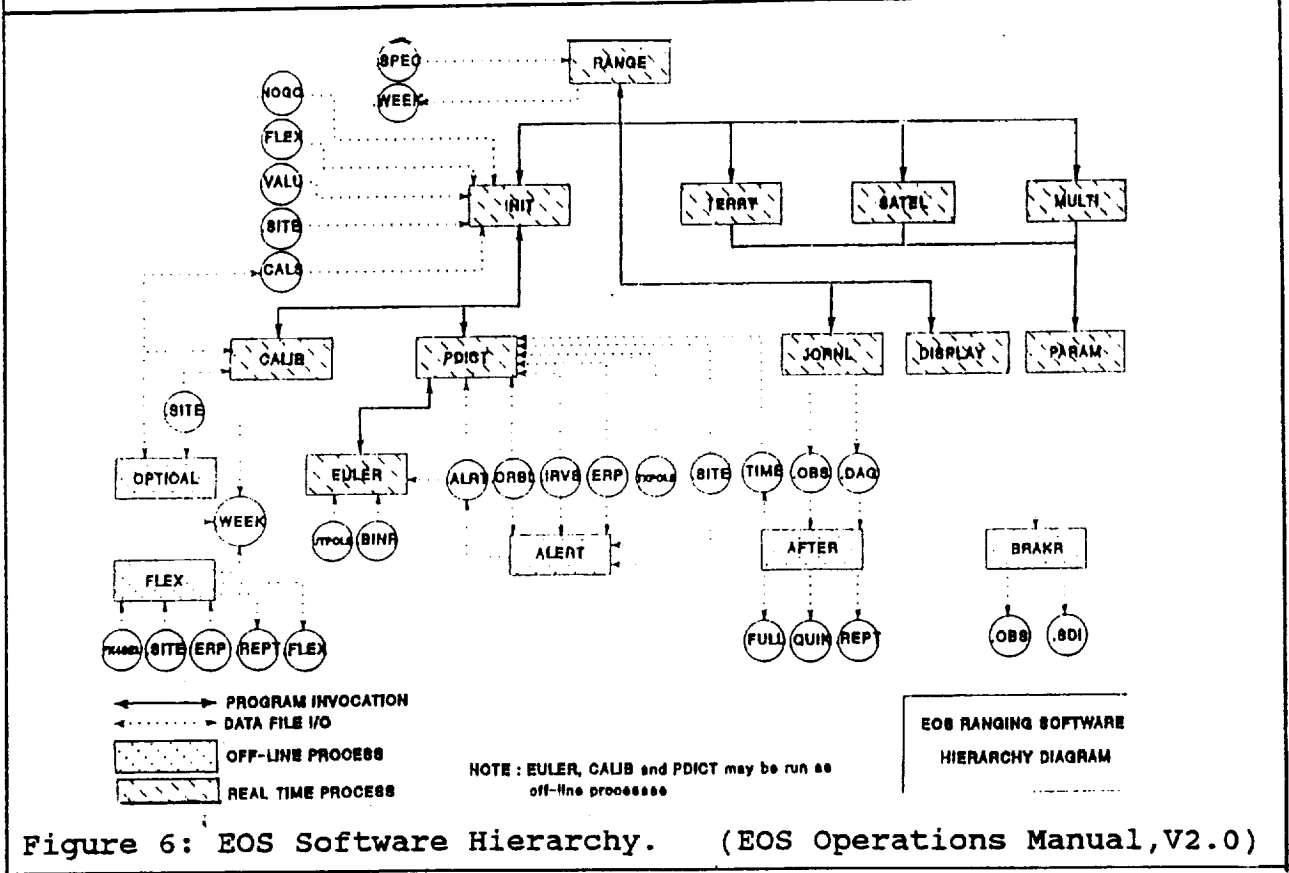

Figure 6: EOS Software Hierarchy. (EOS Operations Manual, V2.0)

RECEIVE ENERGY MONITOR : The previous system based on a LeCroy 2249A ADC has been retained, with hardware gating as above. The EOS software contains an option for automatic gating.

DISCRIMINATOR : As before, Tennelec 454 CFD units are used. EOS has experimented extensively with high-speed comparator chips, delay lines and 'cascade' configurations, but to date Orroral prefers to use unmodified single channels. The upgrade has also provided several potentially useful features for establishing the Z-walk on each channel, such as the PLZT 'wobulator' and software, which are still being evaluated.

OPERATING SOFTWARE : The upgrade software provided, which is summarised in figure 6, includes mount modelling observations and analysis, pass predictions from receipt of IRV/ORBEL files, revamped EULER and IRVINT, ranging operations, post-processing to generation of normal point, full-rate data and time bias files, timing system calibration, file repair, diagnostic and reporting software. Source code was not included. The original software release was designed to apply 'generically' to all EOS systems; it has required considerable tailoring to Orroral's specific configurations, peculiarities, environment and requirements and has necessitated considerable re-education from an entrenched laser ranging 'culture'. Orroral prefers to use its own post-processing software, modified from the Natmap software to handle the new file structures.

Each interface driver is accompanied by a program demonstrating all its calls and providing extensive diagnostic and simulation capabilities. They cover CAMAC, MRCS, MPACS, PADDLE and DOME.

Ranging operations are built around three separate programs that handle ground targets, satellites out to about 70ms two-way range, and 'multiple shots in flight' targets such as ETALON and the moon, respectively.

SYSTEM CALIBRATION : To date, the same methods for real-time internal calibration and ground target ranging have been used as were used during 1987-91. The 'Table Target' on the Coude Table has been tested inconclusively; its signal strengths are expected to be controllable much better than those from the spider retros.

4. Laser Performance

An assessment was performed in April-May 1991 by Dr Barry Luther-Davies of the Laser Physics Centre, Australian National University. The results and many quotations given below are taken from his report (Luther-Davies, 1991). The upgrade to an active/active oscillator and high-efficiency simmered heads has clearly provided very satisfactory performance.

PULSE DURATION : Output from the Second Harmonic Generator was measured using a Hadland Photonics IMACON 500 S20 streak camera

Pulse duration vs Cavity length change

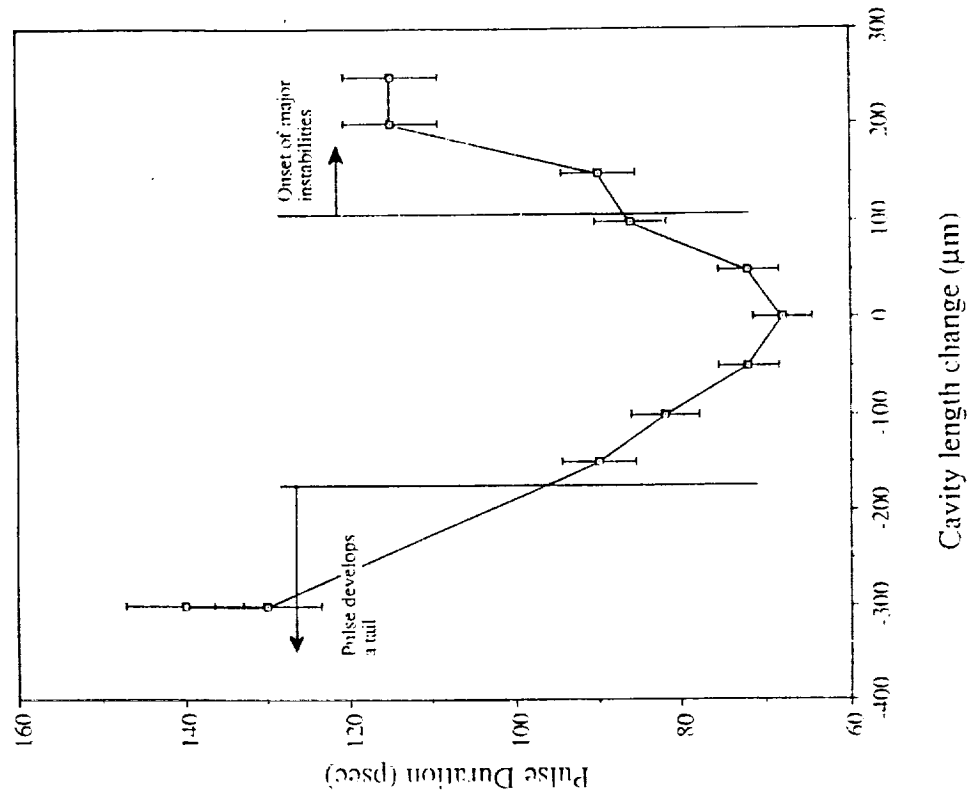

Pulse Duration vs RF Power

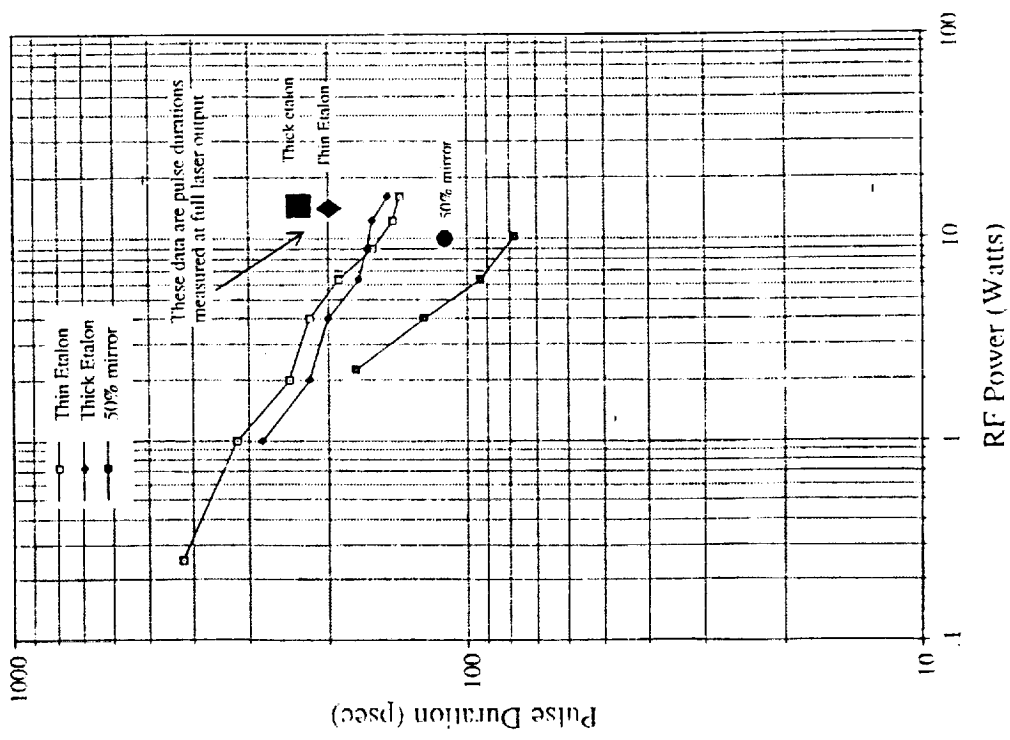

Figure 7: Active-active laser pulse duration- (a) vs RF power to AOM; (b) vs cavity length change. (Luther-Davies, 1991)

whose negatives were digitized with a CCD camera. Three different oscillator output reflectors were tested: a "thin" (3mm) Quantel etalon, a "thick" (6mm) Quantel etalon, and a 50% reflecting dielectric mirror. Pulse durations were measured as functions of RF drive power level to the AOM (figure 7(a)) and of cavity length (50% mirror only - figure 7(b)).

Minimum pulse durations at maximum appropriate RF drive power and full laser power were:

with 50% mirror : 110 +/- 5 ps
 with thin etalon : 200 +/- 10 ps
 with thick etalon : 240 +/- 12 ps.

The 50% mirror was subsequently adopted for normal use, and it was concluded that the oscillator is relatively insensitive to thermal expansion, +/- 5°C on a steel base being tolerable.

LASER OUTPUT ENERGY : Measured with a Scientech volume absorbing calorimeter, with the laser firing at 10 p.p.s. The results are summarised in Table 1. Two settings of the quarter-wave plate between the first and final amplifiers were used, with about a five degree rotation between the settings, to demonstrate the effect of thermally induced birefringence in the amplifiers.

TABLE 1 : Overall Average Laser Output Energy

Position	Energy (mJ)	Comments
Oscillator, pre-lase	0.8	Osc.voltage 1660, RF drive 9.5W
Oscillator, full-train	5.56	Includes pre-lase, 4 pulses
Pulse slicer	1.1	Main pulse switched
Final amplifier, IR	>226.0	Amp.voltage 1420
SHG, green	> 56.0	Amp.voltage 1420, 1/4 wave "1"
SHG, green	> 67.0	Amp.voltage 1420, 1/4 wave "2"
SHG, green	>113.0	Amp.voltage 1570, 1/4 wave "2"

STABILITY : Output power stability was measured at 10 p.p.s. using the Scientech calorimeter or a silicon photodiode as appropriate, connected to a Hewlett Packard chart recorder. The results are given in Table 2. RMS jitter would be 3-4 times smaller than the peak-to-peak values quoted.

TABLE 2 : Short-term Stability of Orroral Active/Active Laser

Position	Av.Power (mW@10pps)	Jitter (p-p,%)	Period (mins)	Detector
Oscillator,full train	60	+/- 0.8	15	Calorimeter
Pulse slicer	11	1.4	15	Calorimeter
Pulse slicer	11	0.7	2	Photodiode (integrated)
Pulse slicer	11	0.8	120 shots	Photodiode (single shots)
Final amplifier,IR	2290	1.2	5	Photodiode (integrated)
Final amplifier,IR	2290	1.6	15	Calorimeter
SHG,green	600	2.0	15	Calorimeter

Worst-case RMS instability lower than 0.5% is inferred.

During these tests, over 100,000 shots were fired and no laser misfires were observed, nor was evidence seen of failure of the mode locking system to generate stable bandwidth limited pulses when the oscillator was correctly aligned.

BEAM PROFILES : The shape of the 532nm output pulse at 1 metre from the SHG was measured with a Pulnix CCD camera. The profiles in figure 8 were obtained: (a) at 40mJ average green energy, at which the beam is quite uniform; (b) at 80mJ, showing a four lobe structure and decreased diameter due to thermal lensing; and (c) at 113mJ with the quarter-wave plate rotated about 5° to emphasise the cross-like pattern caused by thermally induced birefringence in the amplifiers which in turn causes a spatially dependent depolarization of the beam and a variation of the frequency doubling efficiency across it.

5. Timing System Performance

Dr Ben Greene of EOS optimised the 2229A verniers of the epoch timing system in March 1992, and by means of pulses generated internally by the MRCS to simulate start diode and spider retro calibration returns, assessed their stability independently of the influences of MCP, discriminator and signal strength. The results of a 36 minute run where the data is binned in 30 second normal points of approximately 300 simulated shots each, are shown in figure 9. RMS about the mean was 6.2ps (0.93mm), which thus represents the intrinsic precision limit of the system during a LAGEOS pass.

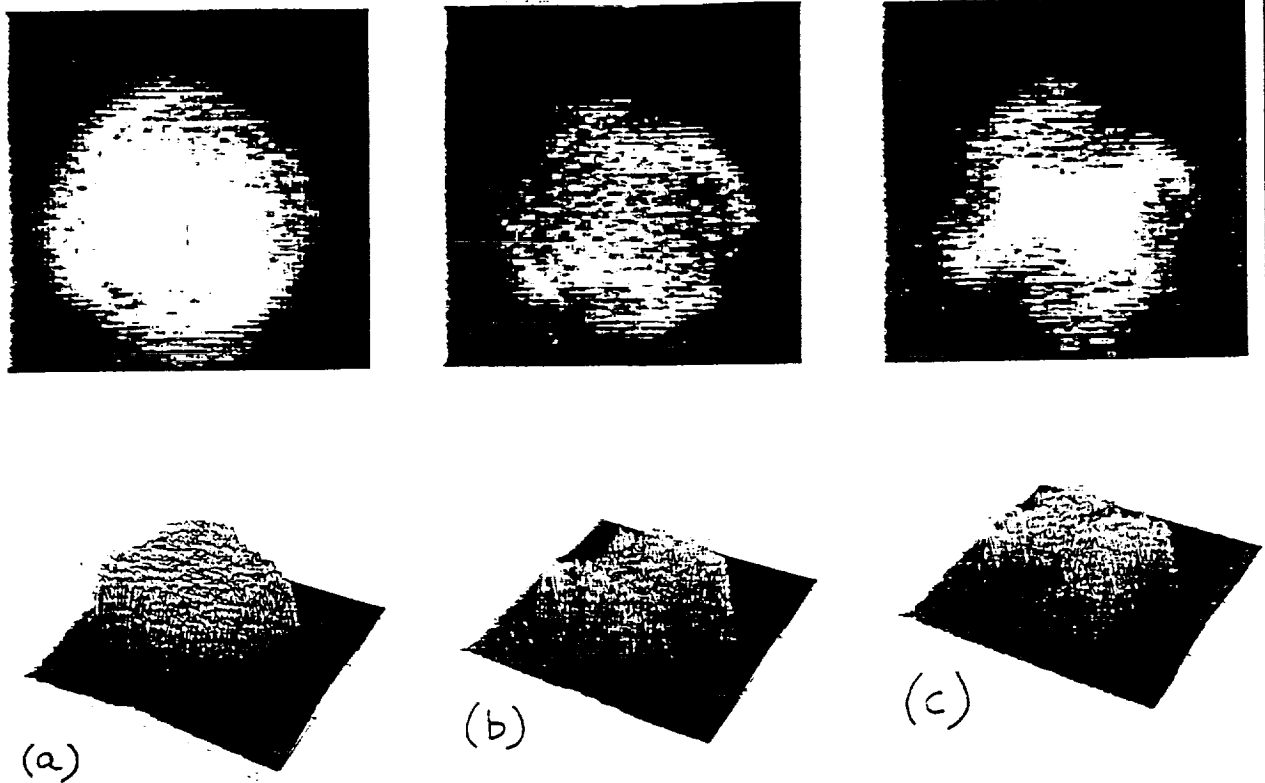

Figure 8: Laser beam profiles, 532nm green output 1m from SHG-
(a) 40mJ/pulse in the green; (b) 80mJ/pulse green;
(c) 113mJ/pulse green, quarter-wave plate rotated 5° .
(Luther-Davies, 1991)

ORROAL CAL STABILITY - RUN 4

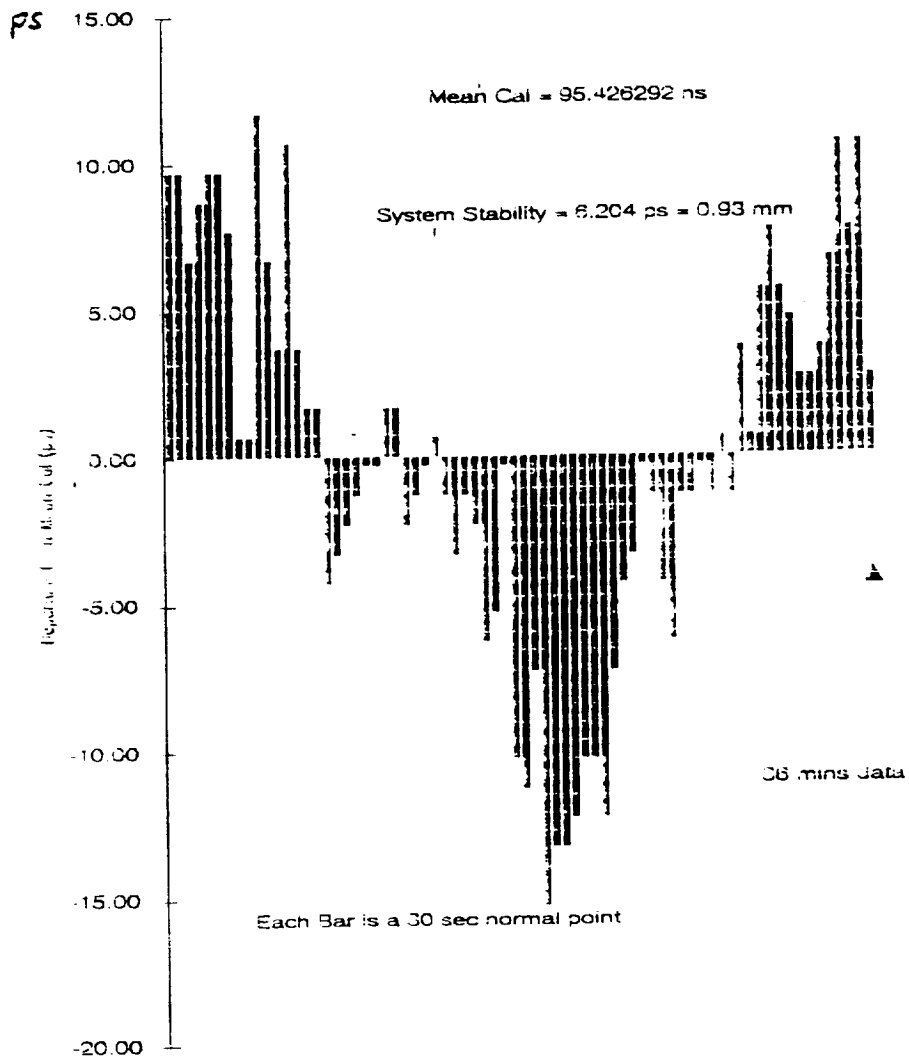

Figure 9: Timing system stability- residuals from mean of 36 minutes of simulated internal calibration data, binned at 30 second intervals (300 shots).

A systematic variation visible in figure 9 may be due to temperature variations in the CAMAC modules. The residuals from a 20 minute run were more random, with RMS 2.4ps (0.36mm).

An estimate of long-term stability is obtained from the daily calibration of the relative delay between verniers. In a 50 day period analysed during which the vernier scale units (ps/count) were held fixed at their values determined at the start of the period, the RMS variation of the delay difference between the two units actually used in ranging was 6.6ps (1.0mm).

It is thus evident that the precision and stability of the system, given perfect discriminator outputs, are 1mm or better. Because range calculations necessarily involve only vernier differences, this value also represents the accuracy limit of the system.

Data on the optical rail method of timing system calibration in situ at Orroral has not been obtained.

6. Pass Productivity

In figure 10(a), the growth in the number of passes acquired per quarter as a result of the upgrade is demonstrated. Prior to March 1991, only LAGEOS I and ETALON I & II (from June 1990) were observable. With the upgrade, STARLETTE, AJISAI and ERS-1 were immediately acquirable, with TOPEX/POSIDON and LAGEOS II being added in the second half of 1992. It is notable that the upgraded Orroral system was the first station to get returns from LAGEOS II, on 24 October. Monthly statistics for January to October 1992 are given in figure 10(b).

An unexpected consequence of the upgrade is that, in view of the enormous increase in number of passes available and the far greater reliability of the upgraded segments of the OLSR, more operational staff are needed in spite of greater system efficiency, and more technical staff are needed to maintain the other segments and bring them to an equal state of reliability and efficiency.

7. System Precision

The evolution of single-shot precision estimates for LAGEOS I ranging from Orroral is shown in figure 11. The data prior to the upgrade come from analyses of full-rate data by Peter Dunn of STX, and from in-house analysis thereafter. The failure to achieve the upgrade's sub-centimetre potential is ascribed to deterioration in laser alignment leading to longer pulses, to the difficulties encountered in optimising the MCP-Discriminator combination, and to a clear dependence of delay upon signal strength. Every effort is made to equalise signal strength distributions from satellite returns, spider retro calcs and

Orroral Pass Productivity

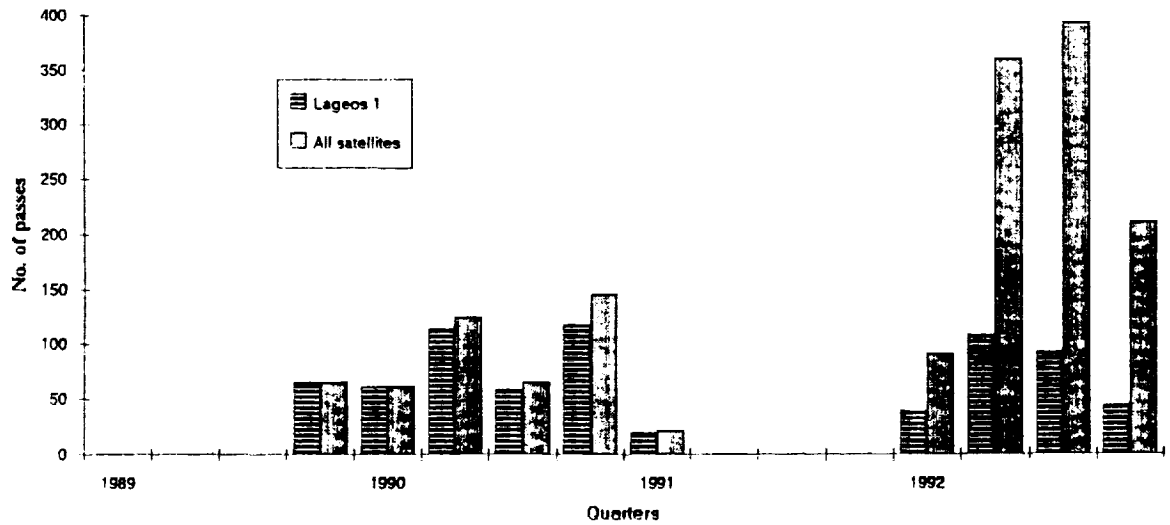

Orroral Pass Productivity, 1992

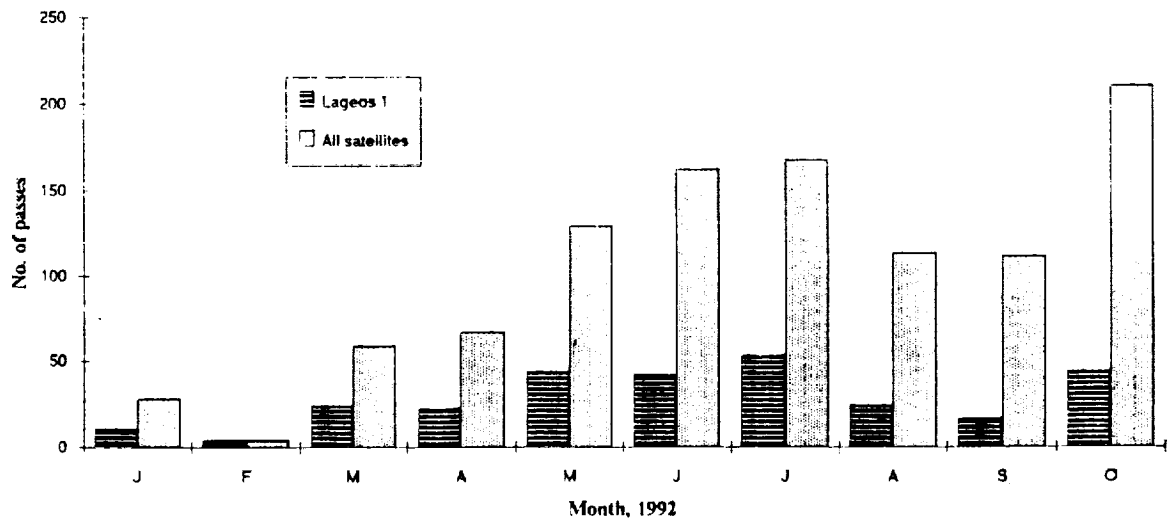

Figure 10: Number of usable passes from OLRs-
 (a) Quarterly, 1990-2; (b) Monthly, 1992.

ground target returns by judicious manipulation of the PLZT and telescope pointing, but it is difficult to do this in practice.

Ground target ranging offers more control over signal strengths. RMS values of 30ps (4.5mm) have been obtained in 5 minute sessions both for raw ground target returns uncorrected for refraction, and for internal calibrations. About 7mm is normal when everything is working properly, as illustrated for a good month in figure 13.

8. System Accuracy

Agreement with external standards is assessed two ways. It has not been possible to organise a co-location experiment.

COMPARISON WITH GROUND SURVEYS : The distance from the ground target retroreflector to all relevant instrumental points was measured by precise geodetic survey in late 1987 and repeated by independent methods and operators in late 1989. The formal one-sigma uncertainty of each survey was 3mm, and agreement was 8mm. The value adopted for the distance between the ground target and spider retro #1 from the more recent survey is 1141624mm.

The same distance is estimated from laser ranging by subtracting the calibration result from the raw range measurement, and applying a refraction correction based on EDM theory and meteorological readings (Rueger,1980). No other corrections for delays inside the telescope are needed. Results for the first ten months of 1992 are displayed in figure 13. The extent to which improvements in signal strength control and laser pulse duration control will decrease the scatter and mean error, remains to be seen.

LAGEOS I RANGE BIAS : Figure 12 shows the range biases before and after the upgrade, relative to LAGEOS I orbits computed by the Center for Space Research, University of Texas (Eanes,1992). There is evidence of a jump of between 20 and 60mm, but it is inconclusive as there could be contamination from orbit errors, station position errors, inclusion of data from 1991 when the upgrade was still being de-bugged, and truncation at May 1992. There has been no change in the constants and procedures used to reduce raw ranges to the adopted instrumental reference point (Coude mirror 7 - see figure 1), nor in the refraction algorithm applied to quick-look data. The orbital reduction procedure is given in Appendix 1.

9. Telescope Pointing

MOUNT MODELLING : The analytical model developed previously for the Contraves mount and MPACS encoder system was specially coded into the generic EOS software. There are 10 parameters for each axis. It is solved from star observations by a non-linear process with observed encoder readings as the basic arguments. (The previous implementation by Natmap was solved as a linear

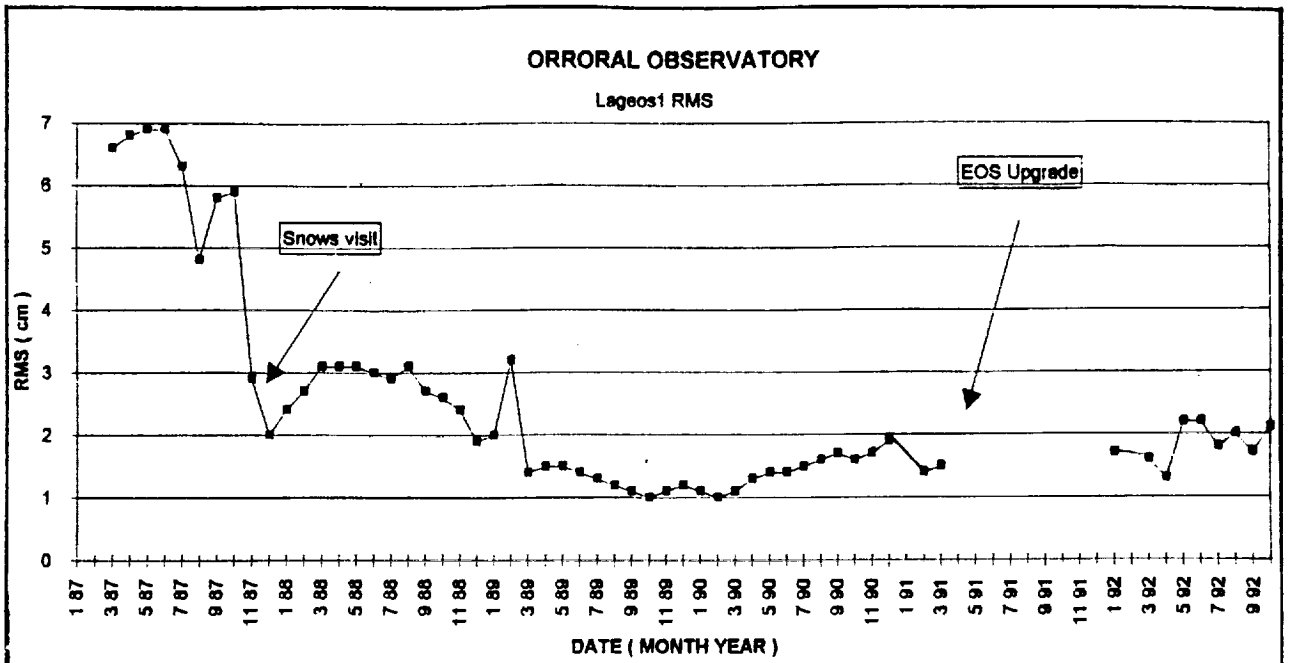

Figure 11: Monthly single-shot precision estimates for ranging to LAGEOS 1 from Orroral.

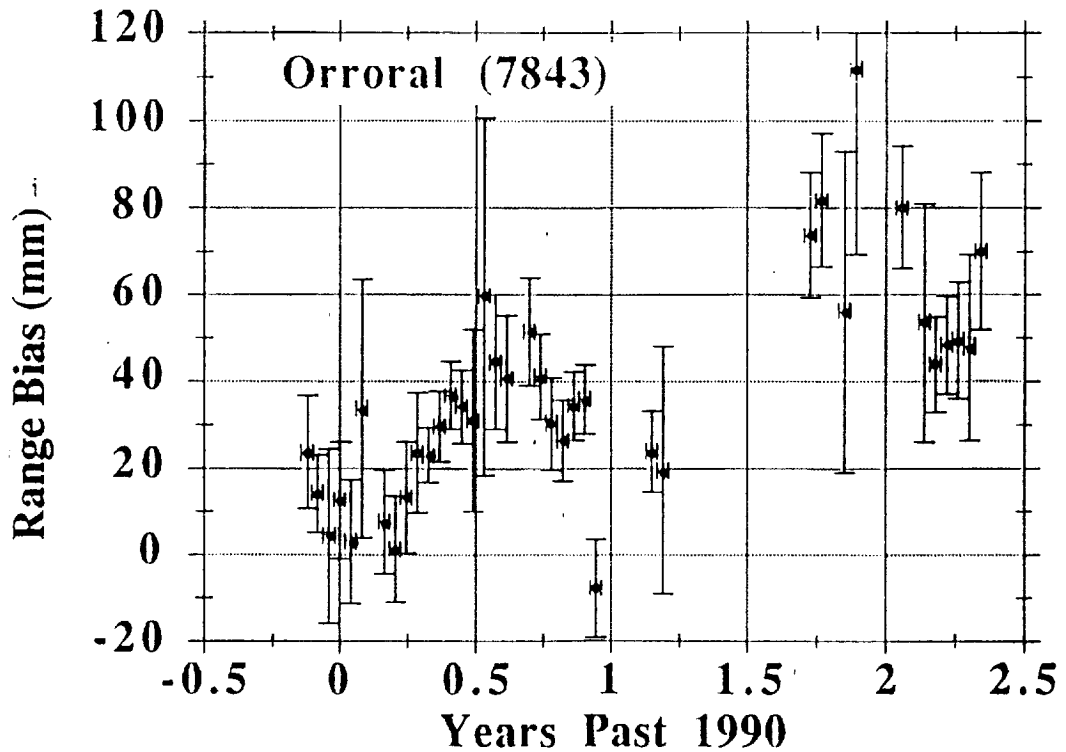

Figure 12: Two-week range bias estimates for ranging to LAGEOS I from Orroral, 1989-92. (Eanes, 1992)

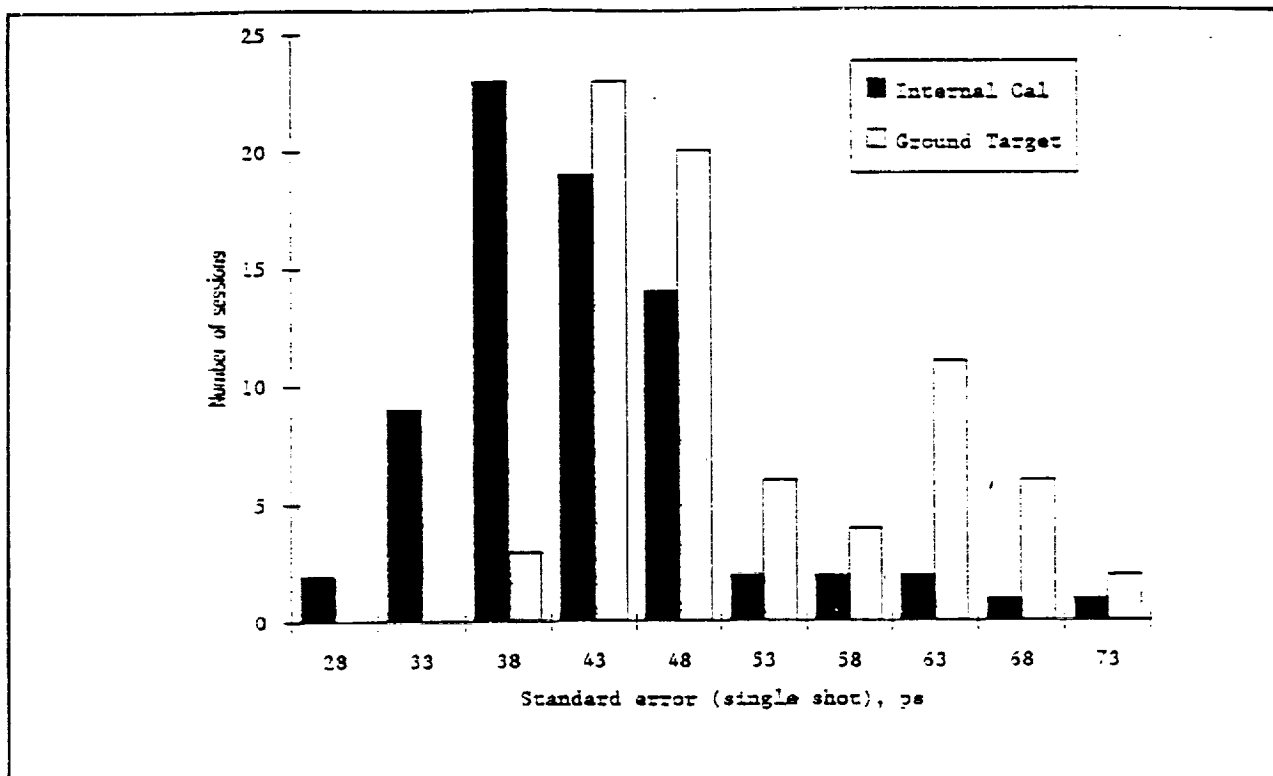

Figure 13: Raw ground target ranging precision (RMS) estimates, for sessions of about 5 minutes each in one month.

ORRORAL GROUND TARGET RANGING

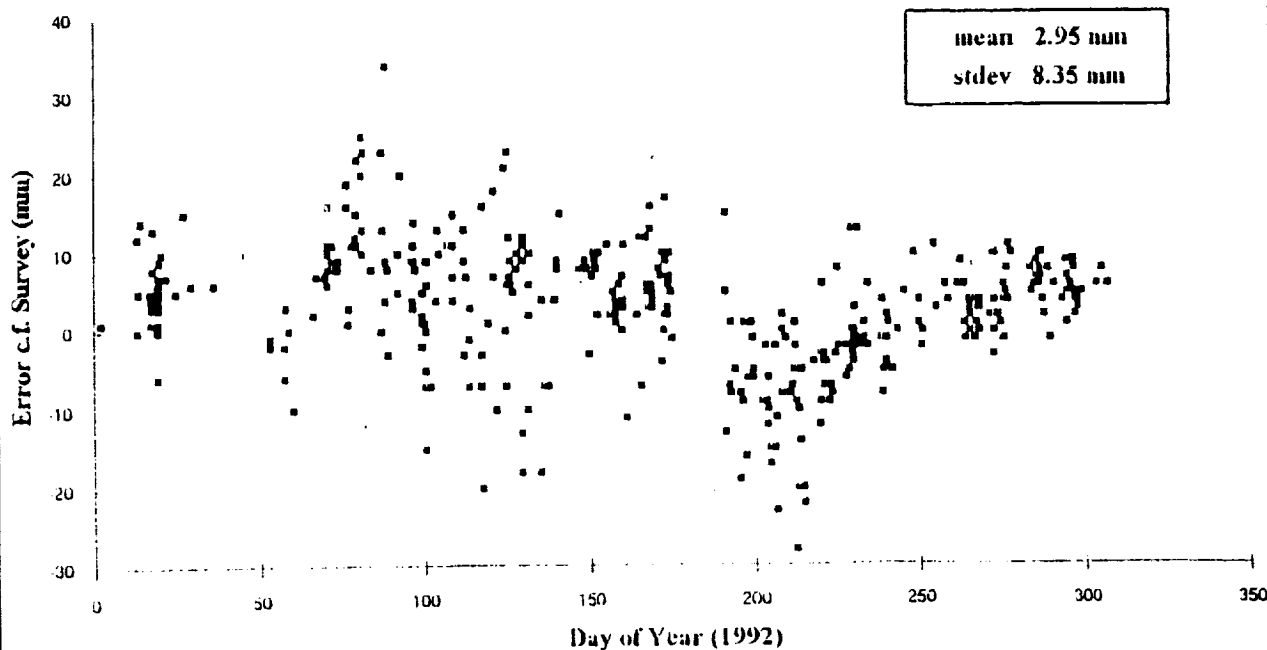

Figure 14: Comparison of reduced ground target ranging results in 1992 against adopted survey values.

model with ideal encoder readings as arguments.) The model is described in Appendix 2.

The star catalogue used is the FK4; previously, we used the homogeneous Perth 70 catalogue, which has a denser distribution.

Star observations are accomplished at the eyepiece at the Cassegrain focus. Star images are set, not on the eyepiece graticule centre but on the image of the coincident 'green spots' formed by returns from the two retroreflectors on the secondary mirror's spider vanes while the laser is firing. Thus the star is set in the direction in which the laser is actually transmitted, which automatically accounts for misalignments in the Coude path.

A feature of the upgraded system is that, between each repeat observation (normally 3) on each star, the telescope is driven off in a random direction to minimise personal bias and any backlash. In other respects, observing speed and the star selection algorithm are inferior to those prior to the upgrade.

HANDPADDLES : For operator convenience in both star observations and ranging, the new handpaddles have thumbwheels to select the resolution of each 'click' of the paddle buttons. This feature has proven very useful.

POINTING ACCURACY AND PRECISION : The post-fit standard error of a full mount model solution from more than 20 stars is typically 3 seconds of arc. The upgrade's solution software does not provide the facility to assess numerically how closely the current model points to stars, so it has to be done at the eyepiece. Our estimate is 5-10 seconds of arc, which is also the typical pointing error to the more distant satellites.

10. Future Upgrades and Extensions

The EOS system is designed to be open-ended for future development. Post-upgrade projects already completed or in-hand include:

- . Semi-automatic ranging operations;
- . Variable speed dome automation;
- . Implementation of 'Table Cals';
- . Variable optical attenuation for satellite returns;
- . Optical design and fabrication for SPAD installation;
- . HP 9000-series Unix workstation for all displays, processing and graphical user interface, leaving the HP A-900 only for instrument control.

while projects made possible in the more distant future include:

- . Fully automatic ranging;
- . Converting laser to travelling-wave 'ring' design;
- . Operating at 40 shots per second;
- . Multi-colour ranging.

An important development not directly related to the upgrade but necessary for lunar ranging and desirable for optimum focussing on to a SPAD, is a new telescope secondary mirror which should be installed by July, 1993. Its distance from the primary mirror was reduced by 4cm at the 1981 upgrade, which introduced enormous aberrations in the Ritchey-Chretien system because it was inadvertently assumed to be a true Cassegrain at the time (see, e.g. Schroeder, 1987). A new optical prescription has been calculated which retains the existing primary mirror, matching assembly and tailpiece optics, reduces the inter-vertex distance by a further 4.5cm, eliminates coma and spherical aberration from the telescope, and reduces them considerably in the matching lens assembly (James, 1992).

The heavily aberrated field-of-view at the pinholes in the receiver assembly is essentially zero (James, 1992). The layout of assemblies on the Coude Table is being studied, to bring the receiver optically closer to the Beam Expander, if possible, in order to increase the field-of-view somewhat.

11. Acknowledgements

The financial support of IRDB, EOS and AUSLIG is gratefully acknowledged. The Orroral Observatory Advisory Committee chaired by Kurt Lambeck, and AUSLIG management particularly Grahame Lindsay, Wal Lamond, Peter O'Donnell and John Manning, were instrumental in initiating the upgrade. The staff of EOS led by Ben Greene with Grant Moule as Project Manager, and all the staff of Orroral Observatory, worked long and hard to instal and debug the new systems and mate them to Orroral's needs and environment.

Special thanks to John Degnan for his patience waiting for this manuscript, and to Mark Elphick and Steve Cootes for their beautiful drawings and graphs.

12. References

- Eanes, R. (1992): Private communication, May.
James, W.E. (1992): "Report on Visit to Orroral Valley Laser Ranging Observatory", Contract Report, James Optics P/L, July.
Luther-Davies, B. (1991): "AUSLIC Laser Operating Manual and Test Data", Contract Report, Australian National University, June
Rueger, J.M. (1980): "Introduction to Electronic Distance Measurement", Monograph No.7 (2nd Ed), The School of Surveying, University of New South Wales, March.
Schroeder, D.J. (1987): "Astronomical Optics", Academic Press Inc.

APPENDIX 1 : CORRECTIONS TO LASER RANGING OBSERVATIONS

Notation

- r : Raw range measurement - time interval between start diode epoch and MCP satellite return epoch (2-way, ns)
R : Reduced range from instrumental reference point (Coude mirror 7) to reflection point of target, influenced by atmospheric delay (2-way, ns)
c : Internal calibration - time interval between start diode epoch and MCP spider retro cal epoch (2-way, ns)
a : Excess path length traversed by satellite returns in T/R box over path traversed by internal cal returns (1-way, ns)
h : Distance between spider retro and centre of telescope tertiary mirror, projected on to optical axis (1-way, ns)
s : Distance between centre of telescope tertiary mirror and system instrumental reference point which is the nominal centre of Coude Mirror 7 (outside the North bearing) (ns)
g : Angle subtended at Coude Mirror 7 by the separation between the telescope's inner (Y) and outer (X) axes (rad)
A : Telescope azimuth (ideal, ie assumes all mount model terms are zero)
E : Telescope elevation angle (ideal)
X : Telescope outer axis angle - 0° W, 90° meridian, 180° E
Y : Telescope inner axis angle - 0° N, 90° prime vert, 180° S

Coordinate Transformations

$$\begin{aligned}\cos Y &= \cos E \cos A \\ \cos X \sin Y &= -\cos E \sin A \\ \sin X \sin Y &= \sin E\end{aligned}$$

$$\begin{aligned}Y &= \cos^{-1}(\cos E \cos A) \\ X &= \tan^{-1}(\sin E / (-\cos E \sin A))\end{aligned}$$

Range Reduction

$$R = r - 2*[s*\cos(Y + g) - h] - [c + a]$$

It is left to the analysts to convert to one-way range and to apply refraction and centre-of-mass corrections.

Numerical Values of Constants

s =	10.0389 ns	(corresponding to 3.010 metres)
g =	0.16624 rad	(corresponding to 9.525 degrees, axis offset 495 mm)
h =	8.9896 ns	(corresponding to 2.695 metres)
a =	1.644 ns	(satellite targets)
	0.000 ns	(terrestrial targets)

APPENDIX 2 : ORRORAL MOUNT MODEL

Notation

X : Encoder reading, actual, outer axis
 X_0 : Encoder reading, ideal, outer axis
 Y : Encoder reading, actual, inner axis
 Y_0 : Encoder reading, ideal, inner axis
 p : $X_0 - 90^\circ$: zero at zenith
 q : $Y_0 - 90^\circ$: zero at zenith
 $c_i, i=1, \dots, 20$: Solution coefficients of mount model, either axis
 $f_i, i=1, \dots, 20$: Mount model functions, either axis

Linear Model

$$\begin{aligned}
 X &= X_0 + c_1 * f_1(p, q) + c_3 * f_3(p, q) + c_5 * f_5(p, q) + \dots \\
 Y &= Y_0 + c_2 * f_2(p, q) + c_4 * f_4(p, q) + c_6 * f_6(p, q) + \dots
 \end{aligned}$$

Functions

i	Function $f_i(p, q)$	Description	Small Angle Expansion
<u>Outer axis (X)</u>			
1	1	X encoder zero point error	1
3	p	X encoder scale error	p
5	q	Cross scale error (empirical)	q
7	1 - cos p	X encoder de-centering	$p^2/2$
9	-sin p tan q	Outer axis inclination error	pq
11	1 - sec q	Optic axis non-perp to inner axis	$-q^2/2$
13	p - tan p	Yoke (outer axis) flexure	$-p^3/3$
15	cos p tan q - q	Outer axis azimuth error	$-p^2q/2 + q^3/3$
17	p - sin p sec q	Telescope tube flexure (sin z)	$p^3/6 - pq^2/2$
19	q - tan q	Non-orthogonality of axes	$-q^3/3$
<u>Inner Axis (Y)</u>			
2	1	Y encoder zero point error	1
4	q	Y encoder scale error	q
6	p	Cross scale error (empirical)	p
8	1 - cos q	Y encoder de-centering	$q^2/2$
10	tan p sin q	Empirical	pq
12	1 - cos p	Outer axis inclination error	$p^2/2$
14	q - cos p sin q	Telescope tube flexure (sin z)	$q^3/6 + p^2q/2$
16	tan p cos q - p	Empirical	$-pq^2/2 + p^3/6$
18	sin q - q	Empirical	$-q^3/6$
20	p - sin p	Outer axis azimuth error	$p^3/6$

Empirical terms were determined by residual analysis. Terms are ordered by small angle expansions around zenith which aids de-correlation of solution parameters especially with few stars.

**SUB-CM Ranging
and other improvements
in Graz**

Georg KIRCHNER, Franz KOIDL

SLR Graz / Institute for Space Research
Austrian Academy of Sciences
Observatory Lustbühel, Lustbühelstr. 46
A-8042 GRAZ, AUSTRIA

Tel.: +43-316-472231; Fax: +43-316-462678
E-Mail: kirchner@flubiw01.tu-graz.ac.at

1.0 Introduction

A lot of tests and experiments have been made in Graz during the last 2 years to increase performance and accuracy; using the SPAD from the Prag group as receiver, we have reached now about 5 mm RMS from the calibration target, and about 8 mm RMS from ERS1 and STARLETTE. In addition, routinely using the semitrain, the number of returns has been increased significantly for most satellites.

2.0 Experiments

In January 1991, together with the Prague group, we installed their streak camera as a receiver in the Graz laser telescope, and first echoes from AJISAI and STARLETTE could be recorded.

In December 1991, again together with the Prague colleagues, 2-color ranging experiments were performed, using Raman upshifted red (683 nm) and 532 nm wavelengths; returns of both colors from AJISAI and LAGEOS could be recorded. A detailed description of both experiments is given elsewhere in these proceedings.

3.0 Accuracy Improvements

As stated already during the Matera workshop, the contribution of the SPAD itself to the overall jitter can be decreased by using higher voltages above break (V_{ab}). Modifications of the original SPAD electronics now allow us to increase this V_{ab} to more than 10 V, resulting in a jitter of 5 mm RMS (fig. 1) from the calibration target. In this test, we used an SR620 counter, which also contributes to the lower RMS (the start input of the SR620 handles the output of the start Optoswitch significantly better than our HP5370A).

The well known disadvantage of the high V_{ab} is the increase in noise; while a standard SPAD at 2.5 V_{ab} at room temperature has an acceptable noise of about 200 kHz or less, this increases at 10 V_{ab} to about 1 MHz (fig. 2). To reduce this, we cool the SPAD now with Peltiers to -25°C , reaching again about 200 kHz noise.

Short before the workshop, we had 4 different counters available for test purposes at the SLR Graz: HP5370A, HP5370B, and 2 SR620. The RMS values of these specific instruments are listed in table 1; RMS 1 is measured with asynchronous, random pulses, as it is the case during satellite ranging; RMS 2 is measured with pulses synchronous to the internal frequencies, and is listed here only for completeness.

	RMS 1	RMS 2	Remarks
HP 5370A	22 ps	10 ps	Our standard counter for SLR
HP 5370B	40 ps	12 ps	Available for tests
SR620/1	21 ps	8 ps	Our future counter for SLR
SR620/2	20 ps	8 ps	Same type, available for tests

Table 1: Counter Comparison

Using these counters in our station for calibration tests, we got the results shown in fig. 3. We measured all counters with "good alignment" (the returns focussed as good as possible on the center of the SPAD) and "weak alignment" (focussing of the re-

turns on the SPAD far from optimum). It can be seen that good SPAD alignment (together with optimizing all start/stop input pulse rise times, pulse forms, trigger thresholds etc.) is of the same importance than selecting the proper counter.

4.0 Routine use of the Semitrain

Since summer 1991, we routinely use the second half of the pulse train (semitrain), delivered from our Nd:YAG laser, for all SLR measurements. The software has been modified to allow for automatic "folding" of the returns. Fig. 5 shows an example pass of LAGEOS, with totally 7 tracks (or pulses from the semitrain) identified later by the software.

By using all returns from the semitrain, the number of returns for most satellites could be increased significantly (fig. 6); for LAGEOS the increase in returns is more than 50%; for the ETALON's, it is more than doubled.

5.0 Acousto-Optic Modelocker

In February 1992, we installed an Acousto-Optic Modelocker in our old Nd:YAG laser oscillator, inceasing reliability and shot-to-shot reproducibility of the laser pulses. Besides increasing the number of valid shots from our previous average of about 70% (it was an old, purely passiv modelocked oscillator!) to more than 99%, the much better stability of the pulses had a noticeable effect on the jitter (Fig. 4); the routine cal. values showed better stability and even slightly lower RMS (the AO-Modelocker was installed after calibration number 98, in fig. 4).

The AO-Modelocker requires temperature stabilization; this is done by slightly heating it to 27°, using the hot side of Peltier elements; the cold side of these elements is used at the same time to cool the Dye Cell to about 10°, which should result in a longer lifetime of the Dye. Results are promising (we used the same dye from February to May), but still have to be verified during the next years.

100 μ SPAD #5 (-25°C) / SR620 JITTER + MEAN CAL vs. VAB

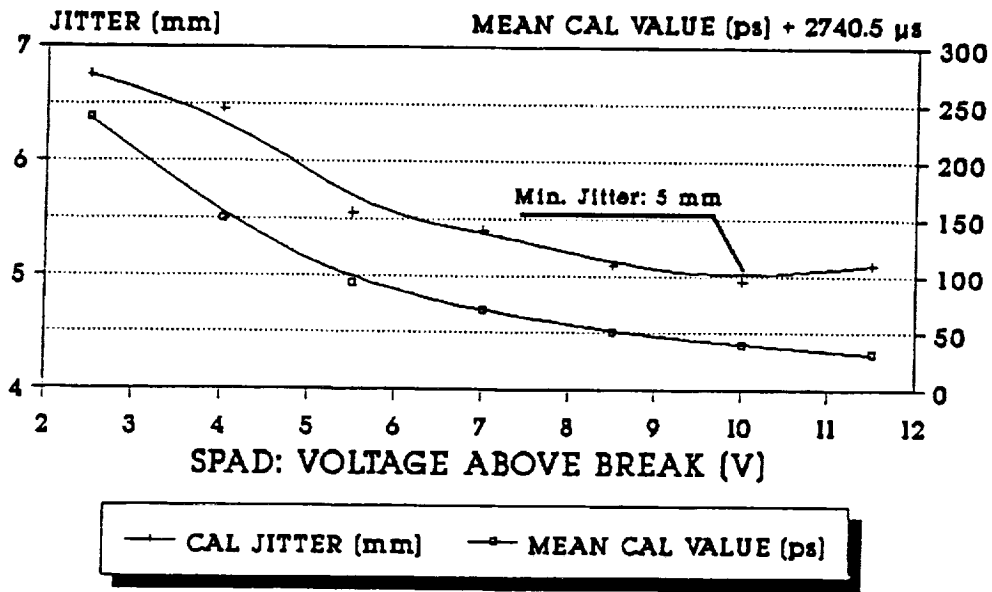

1992-05-15

Figure 1: Minimum Jitter from Target is about 5 mm

100 μ SPAD #5 Dark Noise Temperature Dependence

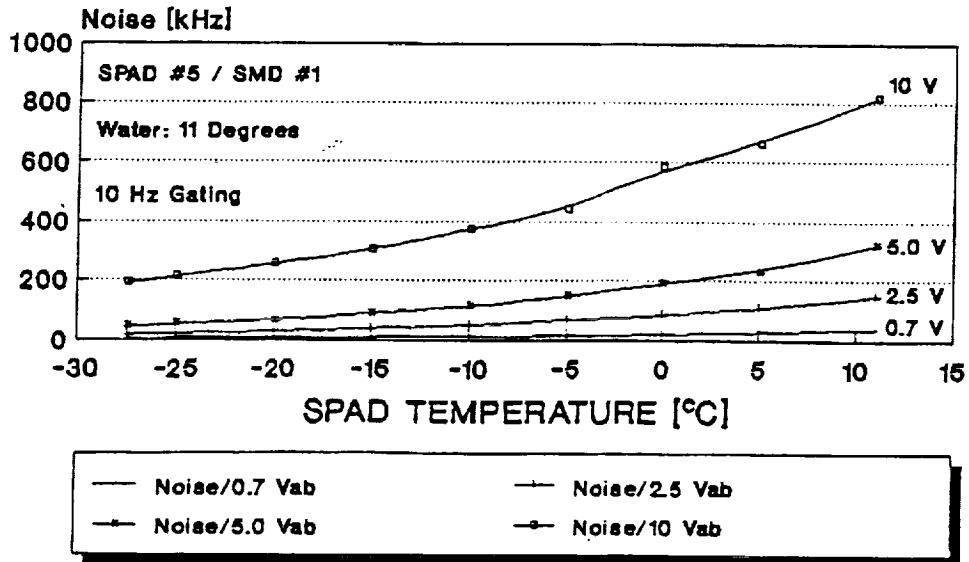

1992-05-15

<KG/KF>

Figure 2: Noise depends on Voltage above break and temperature

COUNTER COMPARISON EXT. CALIBRATION JITTER

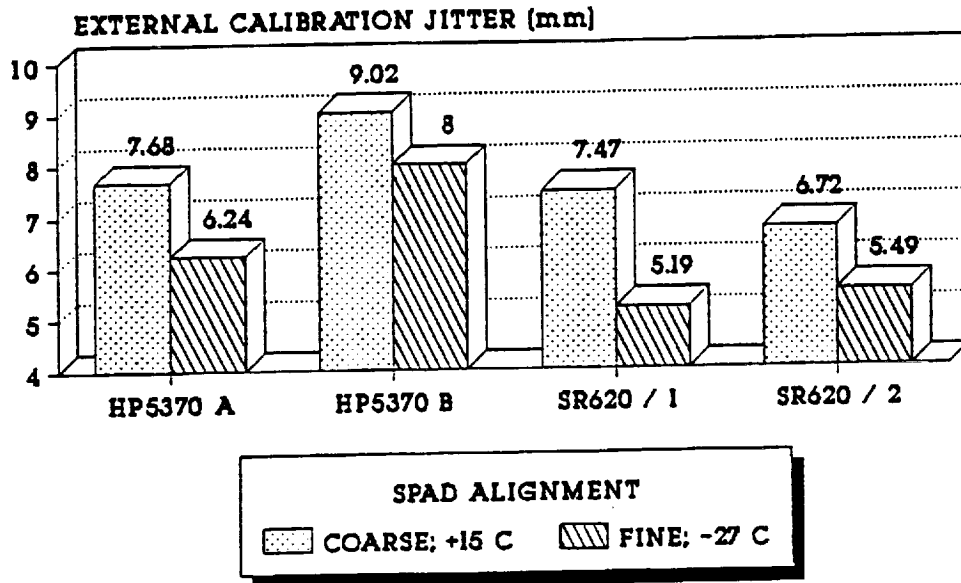

1992-05-13

Figure 3: Calibration with different counters and alignments

LASER STATION GRAZ Calibration Jitter

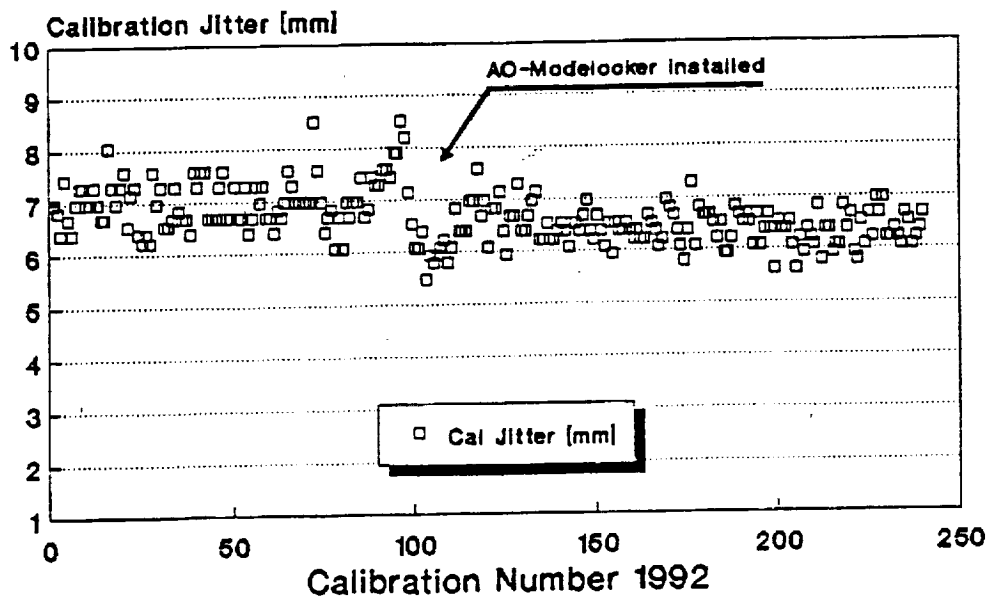

Cal Jitter of routine passes 1/92-3/82

Figure 4: Effect of Acousto-Optic Modelocker on Cal stability

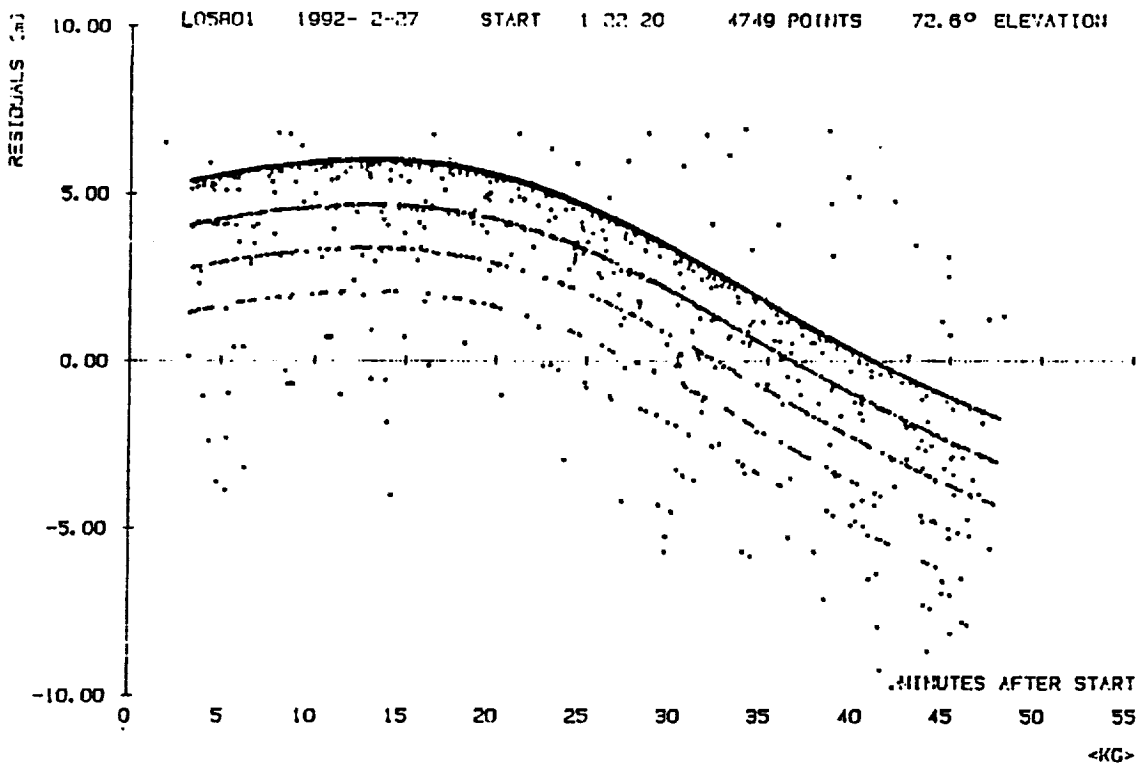

Figure 5: Typical LAGEOS pass, with semitrain returns

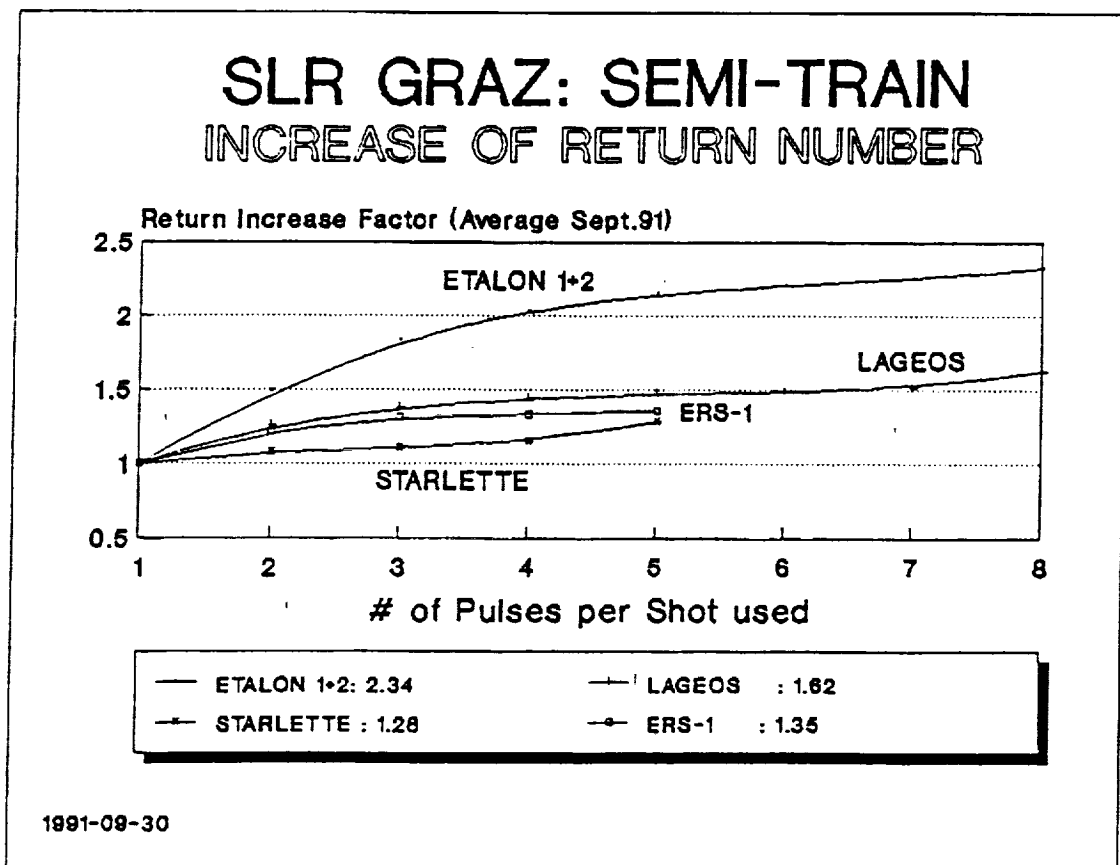

Figure 6: Increase of return number with semitrain

N94-15604

UPGRADING OF THE BOROWIEC LASER STATION

S.Schillak, E.Butkiewicz, J.Wiktorowski
Space Research Center of Polish Academy of Sciences
Astronomical Latitude Observatory
Borowiec 91
62-035 Kornik, Poland

Telephone: (48) 61-170-187
Fax: (48) 61-170-219
Telex: 412623 aos pl

Abstract

The major upgrade at Borowiec SLR since the last Workshop is the new third generation laser, which has been installed in September 1991. Short description of the new CONTINUUM laser and first results of satellites observations are presented. The results confirm expected increase in accuracy (3-5 cm) and in the number of measurements per satellite pass (several hundred).

In addition, information about second Borowiec SLR system is presented. Borowiec No 2 is designated for Tunisia in the next year. System is not yet operational.

1. Introduction.

The Borowiec SLR System is operating since 1988 (Schillak, 1991). During this time the system has provided observations to satellites LAGEOS, Ajisai, Starlette, GEO-1K-1 and ERS-1. The system has only night-time tracking capability. The single shot precision was estimated to be about ± 20 cm. Our activity were strongly limited by bad weather conditions and technical problems (Fig.1).

Since the last workshop several upgrading in the system has been done;

- 1990, February, transmitter telescope has been added and divergence of laser beam changed 8X,
- 1990, October, generation of normal points onsite,
- 1990, October, replacement of the photomultiplier FEU-87 by the RCA 8852,
- 1991, June, a received energy detector has been introduced,
- 1991, September, new third generation laser has been installed,
- 1991, October, new real-time software has been introduced,
- 1992, January, microcomputer PC/AT has been used for pre- and post-observation programs, real-time graphic program on PC/AT has been added.

The main upgrading of the system was installation of the new laser.

2. Laser CONTINUUM.

The Nd:YAG laser type CONTINUUM PY-62-10 has been employed in September, 1991. The scheme of the laser transmitter is shown in Fig.2. The laser is a cavity dumped active/passive mode-locked system. The cavity dump consist of the electro-optic Pockels cell triggered by a photodiode. The selected output single pulse is ejected via polarizer when the predetermined intensity level is reached. The oscillator delivering about 3-5 mJ at 1064 nm. The oscillator and preamplifier are pumped by the same flashlamp. A telescope for beam expansion is placed before main amplifier. The amplifier has four flashlamps. A type II KD*P crystal is used for

doubling.

The laser can be operated in two different modes;

- with ETALON (100 ps, 110 mJ at 532 nm),
- without ETALON (35 ps, 65 mJ at 532 nm).

The pulse repetition rate can be varied from 1 to 10 Hz (10 Hz is optimum). Pulse stability - 7%, diameter of output laser beam - 12 mm, divergence - 0.4 mrad, jitter of ext. trig. ± 10 us.

3. Results.

The last pass with old 4 ns laser was performed on August 18, 1991, first pass with new CONTINUUM laser on September 28, 1991. The results of SLR using new laser are shown in Table 1. The table shows results of two periods of activity; I - October, November, II - December, January. First period was dedicated to the introducing of new real-time software, second one to achieve maximum efficiency in actual station configuration. The last results show that single shot RMS is equal to 3-5 cm and further increasing of accuracy is limited by classic photomultiplier RCA 8852 (jitter is about 1 ns). Maximum number of returns per one pass was about 1500 for LAGEOS and more than 3000 for Ajisai. The Fig.3 and 4 shows the advantages of new laser in comparison to the old one. To further improve the single shot RMS the photomultiplier needs to be changed to a micro-channel plate or an Avalanche photodiode.

Table 1. Results of the observations performed with CONTINUUM laser from September 28, 1991 to January 31, 1992.

SATELLITE	PERIOD	PASSES	RETURNS	RETURNS/ ONE PASS	RMS cm
LAGEOS	Oct-Nov	8	416	52	7.0
AJISAI		12	5313	443	4.8

LAGEOS	Dec-Jan	8	3516	440	5.0
AJISAI		13	17268	1328	4.0

Problems;

- delay of the mount as result of the short steps (100 ms), step by step mode of the mount should be changed to continuous mode, problem is especially hard for low satellites as ERS-1,
- small operational memory of old computer limits our possibility to maximum 2500 returns per pass, also breaks of about 1 min appeared due to 5 min bursts, microcomputer PC/AT must be attached for real-time operations.

4. Status and parameters of Borowiec-2 SLR system.

The second SLR system has been installed in Borowiec Observatory in 1990. The system is destined to place in Tunisia. The parameters of actual configuration are presented in Table 2.

Table 2. The actual parameters (1992) of Borowiec-2 SLR system.

Laser - Nd:YAG

- pulse energy - 250 mJ (green)
- pulse width - 4 ns
- repetition rate - 1 Hz

Mount - Az-El computer controlled

- tracking - continuous
- tracking possibility - low satellites, Lageos, Etalons
- encoder resolution - 1.8 arcsec
- laser in Coude

Transmitting optics

- diameter - 20 cm
- gain - 8x
- output divergence - 10 arcsec

Receiver - Cassegrain

- diameter - 65 cm
- diameter of secondary mirror - 20 cm
- field of view - 5 arcmin

Guide telescope - Maksutov

- diameter - 20 cm
- field of view - 1°

Photomultiplier - RCA 8852
Time Interval Counter - PS-500, 60 ps accuracy
Discriminator - Tennelec 454, or B-6
Time Base - GPS Time Receiver
 accuracy - 100 ns
Computer - PC/AT
Software - Real Time tracking programs, IRVINT and ORBMESS
 predictions, initial analysis programs, star programs
 language - C
Calibration - Pre and Post, external
Expected overall accuracy of the system - ± 15 cm
Operating staff - 2 persons

The current 4 ns laser should be exchanged for the better third generation system in the near future. System is not yet operational. The first target calibration is expected this year and system will be operational at Borowiec in 1993.

5. Localization in Tunisia.

Installation of the SLR station in Tunisia is realized in cooperation between Office de la Topographie et de la Cartographie, Tunisie and Space Research Center of Polish Academy of Sciences. Station will be placed in new geodynamical center 10 km north from town Medenine in south part of Tunisia. The Borowiec-2 SLR system will be operational in Tunisia probably in 1994.

Acknowledgments.

The authors thank technical staff of Borowiec laser group; Ms. Danuta Schillak, Mr. Wojciech Rzanny and Mr. Stanislaw Zapasnik for their important participation in new laser installation and performance of observations.

References.

Schillak S., 1991, Borowiec Laser Station 1986-1990. Artificial Satellites, Planetary Geodesy, No. 15, Vol. 26, No. 1, Warsaw, Poland, pp. 13-18.

Fig. 1 OPERATING PERIODS IN 1990
(284 DAYS)

BAD WEATHER 73 %

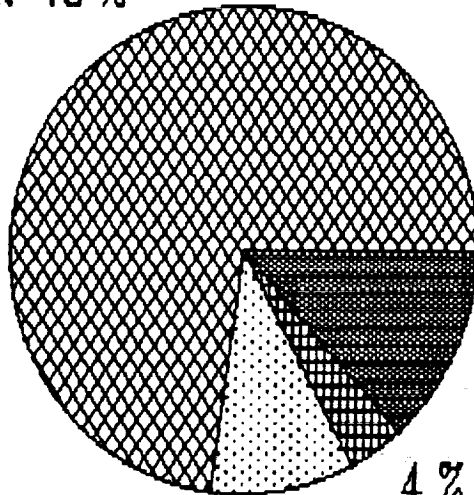

13 % SUCCESSFUL PASSES

4 % OTHER

10 %

TECHNICAL PROBLEMS

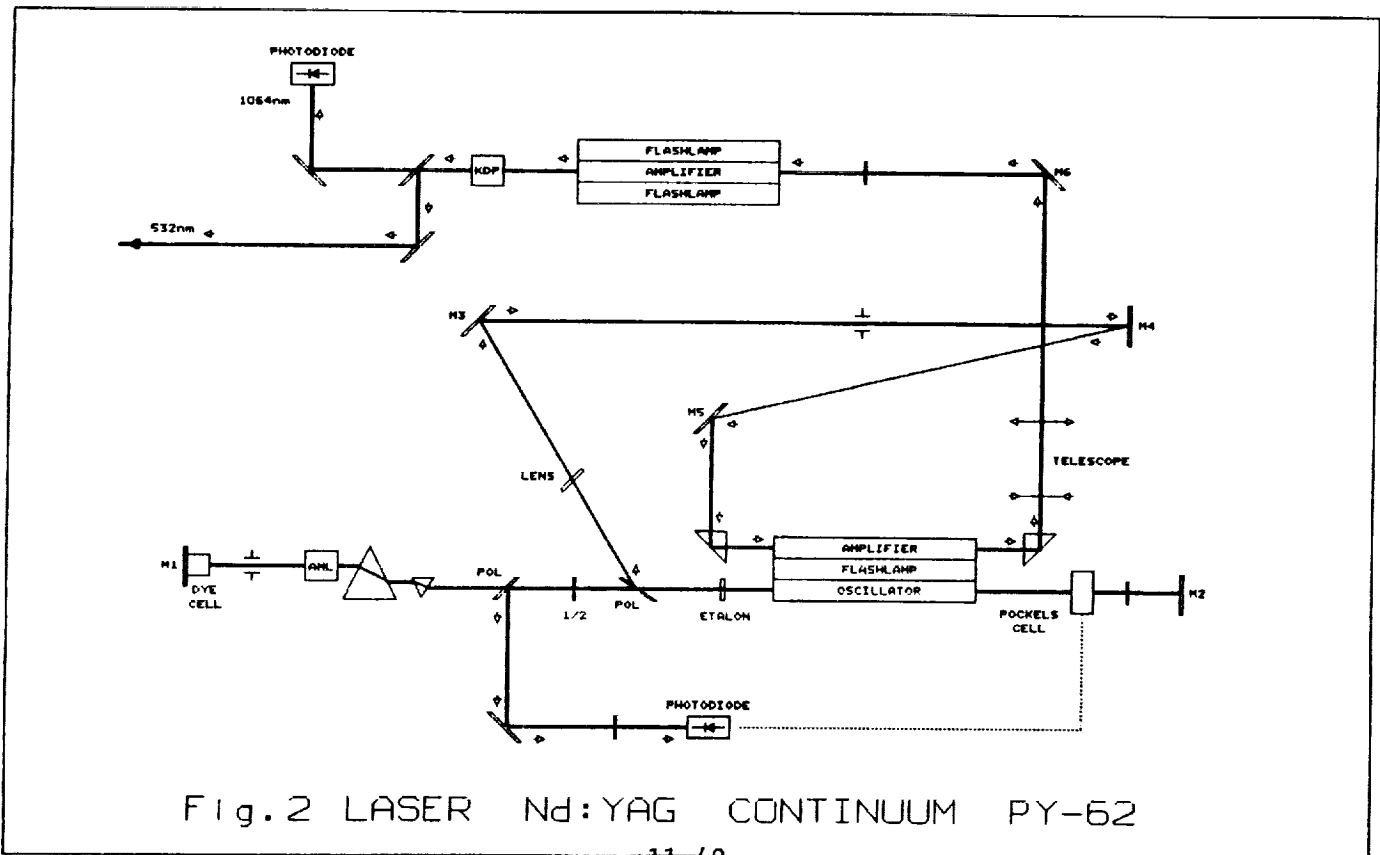

Fig. 2 LASER Nd:YAG CONTINUUM PY-62

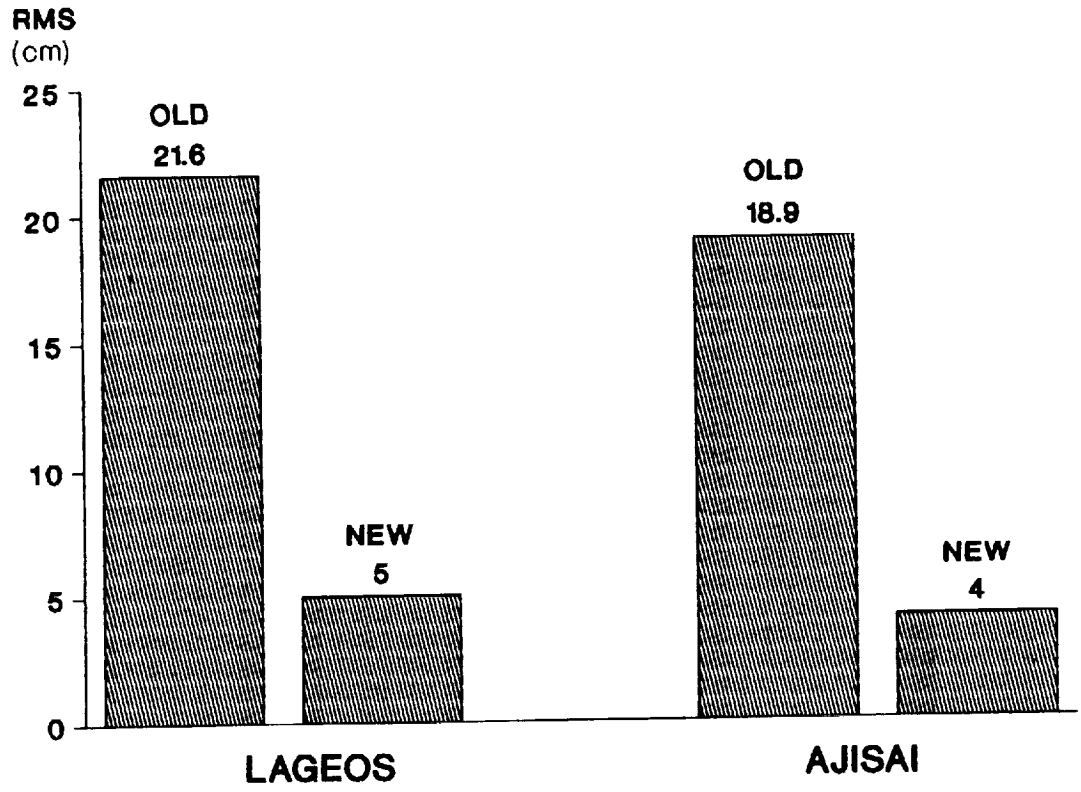

Fig.3 Single shot RMS - old and new laser.

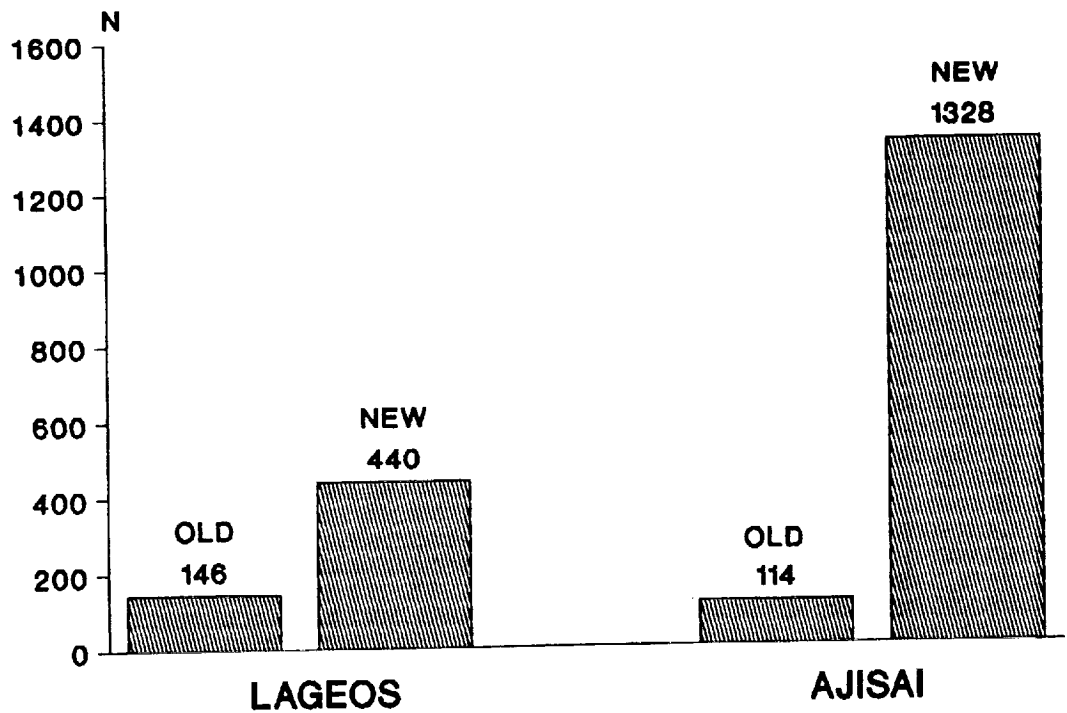

Fig.4 Returns per one pass - old and new laser

Development of Shanghai Satellite Laser Ranging Station

F.M. Yang, D.T. Tan, C.K. Xiao, W.Z. Chen, J.H. Zhang
Z.P. Zhang, W.H. Lu, Z.Q. Hu, W.F. Tang and J.P. Chen

Shanghai Observatory, Academia Sinica
80 Nandan Road, Shanghai 200030, China
Telex: 33164 SHAO CN
Fax: 86-21-4384618
Phone: 86-21-4386191

1. Improvement of the System Hardwares**1.1 Computer control subsystem**

An IBM/286 computer control system was set up during August 1989 to March 1990. After three months, the realtime display of range residuals (O-C) on the computer screen was completed. Since then, only one operator has been needed for the routine observation. The operator can control the whole ranging system by using the computer keyboard during the observation and can watch the image of the satellite while illuminated by the sunlight on the monitor of a SIT TV camera side by side. The system automation and reliability has been greatly improved.

1.2 Laser Subsystem

The Nd:YAG mode-locked laser, which was made by the Shanghai Institute of Optics and Fine Mechanics and installed at the station in 1986, contains an oscillator and three single-pass-amplifiers and can usually produce 50 mj (green) and 180 psec width.

Many work have been done in order to improve the stability on both the laser beam direction and the output energy. A new chiller was installed in November 1991. The repetition rate is 1-2 Hz for Lageos and Etalon ranging, and 2-4 Hz for low orbit satellites ranging. The divergence of the laser is about 0.4 mrad. So, the optimum beam divergence from the transmitting telescope which has a magnification of 6 is about 13 arcseconds. That is good for Etalon satellites ranging. The divergence can be adjusted up to 3 arcminutes for the low orbit satellites ranging.

1.3 Receiver

The ordinary PMT (Type GDB49A, China-made) has been adopted from the set up of the system in 1983 to May 7, 1992 when a single photon avalanche diode (SPAD) receiver made by the Czech Technical University has been installed. The voltage for the diode is about 30 V and the break down voltage is about 27.5 V. The field of view of the new receiver is about 45 arcsec. The noise rate of the SPAD working at above condition is 200-300 KHz even in the nighttime.

A 0.15 nm narrow band filter in a theomostat has been tested in November-December 1991 and has been shown with good performance.

Summary of SLR Observations at Shanghai (7837)

Year Satel.	1988	1989	1990	1991	1992 *
	pass, point	pass, point	pass, point	pass, point	pass, point
Lageos	37, 2625	33, 2555	162, 73782	137, 35071	89, 22409
Ajisai	41, 4033	74, 4323	158, 30594	134, 33183	48, 12637
Starlette	4, 142	12, 332	44, 6135	59, 9122	35, 2946
Etalon-1			38, 22222	21, 3888	13, 1579
Etalon-2			35, 10402	26, 7430	22, 1737
ERS-1				25, 2088	24, 3074
TOTAL	82, 6800	119, 7210	437,143135	402, 90782	231, 44382

* up to May 9, 1992

3.2 Multi-satellite tracking capability

The typical time interval for the system to transfer from one satellite to another is about one minute, including the telescope moves back to the zero point and then travel to the prediction position of another satellite. The shortest time interval from the last return of Lageos pass to the first return of Etalon pass was only 126 seconds.

4. Preliminary Daylight Tracking Capability

After having the above-mentioned improvements, the daylight tracking to Lageos had been tested during November and December, 1991. The first returns in the daylight was obtained on December 20, local time 16:47 P.M. (Fig.3)

The aperture of the receiving telescope is 600 mm, and the field of view of the receiver is 60 arcsec, 0.15 nm (FWHM) filter, PMT Type GDB-49A, the noise rate of the sky background was about 800 KHz.

5. Testing the New Type Laser

In April and May, 1992, a new Nd:YAG laser with an unstable resonator hybridized by nonlinear ring interferometer has been tested for satellite ranging at Shanghai station. Another paper [Yang Xiangchun et al, this Proceedings] introduces the technique for simultaneously compressing of

the passive mode-locked pulsewidth and pulse train. For SLR application, one amplifier and one frequency doubler were added to the oscillator. Without the single pulse selector, the output of the laser system was in pulse train containing only 1-2 giant pulses, and the total energy of the pulse train is about 18 mj (green), 10 psec width, 0.4 mrad beam divergence, 2-4 Hz repetition rate. During May 8-9, the new laser system and the SPAD receiver has been successfully used for Lageos and Etalon-1 ranging. The 2 cm range accuracy has been achieved in both satellite and ground target ranging. (Fig. 4 & 5)

6. Future Plans

6.1 Routine daylight ranging to Lageos and other low orbit satellites.

6.2 Single shot range accuracy will be improved to better than 2cm for routine operation.

6.3 Development of the millimeter level accuracy SLR system

A cooperative plan between Shanghai Observatory and Xi'an Institute of Optics and Precision Mechanics has been set up to develop a mm- level SLR system based on a circular-scan streak tube. A prototype tube has been made by Xi'an Institute in March 1991. The main characteristics of the tube is as follows:

* Photocathode: Type S-20,	Sensitivity	67 μ A / lm
	Spectrum response	200-850 nm
	Effective area	12 mm
* Sensitivity of deflection		10 cm / KV
* Double MCP internal intensifiers		
* Gain		1 X 10 ⁶
* Spatial resolution		24 lp / mm
* Temporal resolution		4.8 psec
* Dynamic range		390:1

This project has been supported by the Chinese National Science Foundation and the Chinese Astronomical Committee, and expected to be operational in 1994.

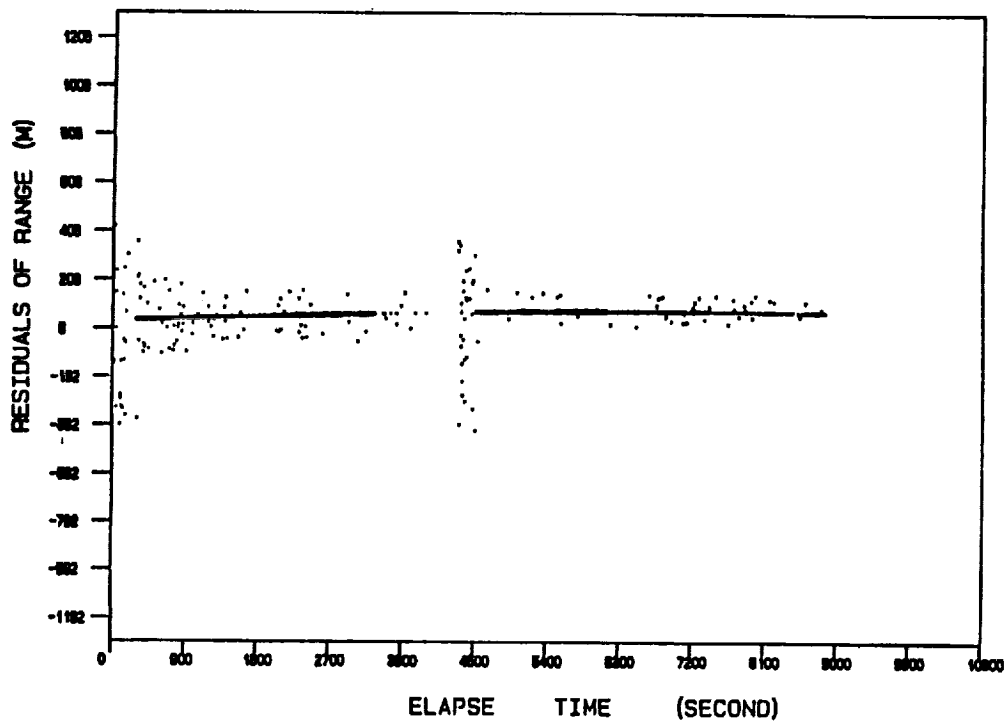

Fig. 1 One pass of Etalon-2 on August 13, 1990, 4138 Observations
 Time (UTC): 11:47 Accuracy(rms): 6cm

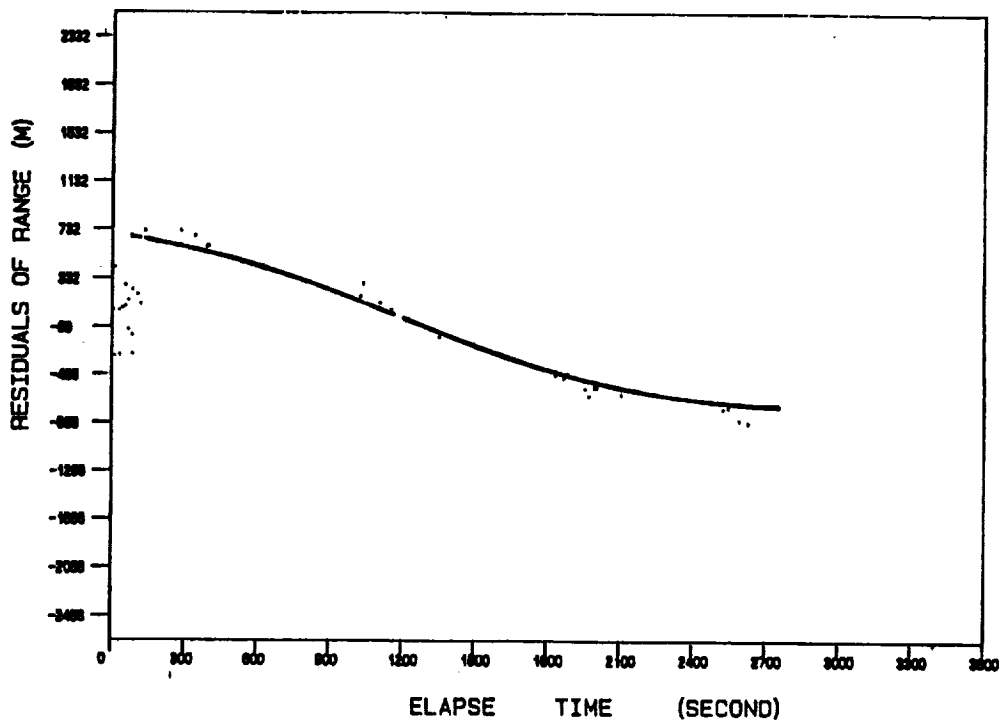

Fig. 2 One pass of Lageos on July 28, 1990, 2865 Observations
 Time (UTC): 18:17 Accuracy(rms): 5cm

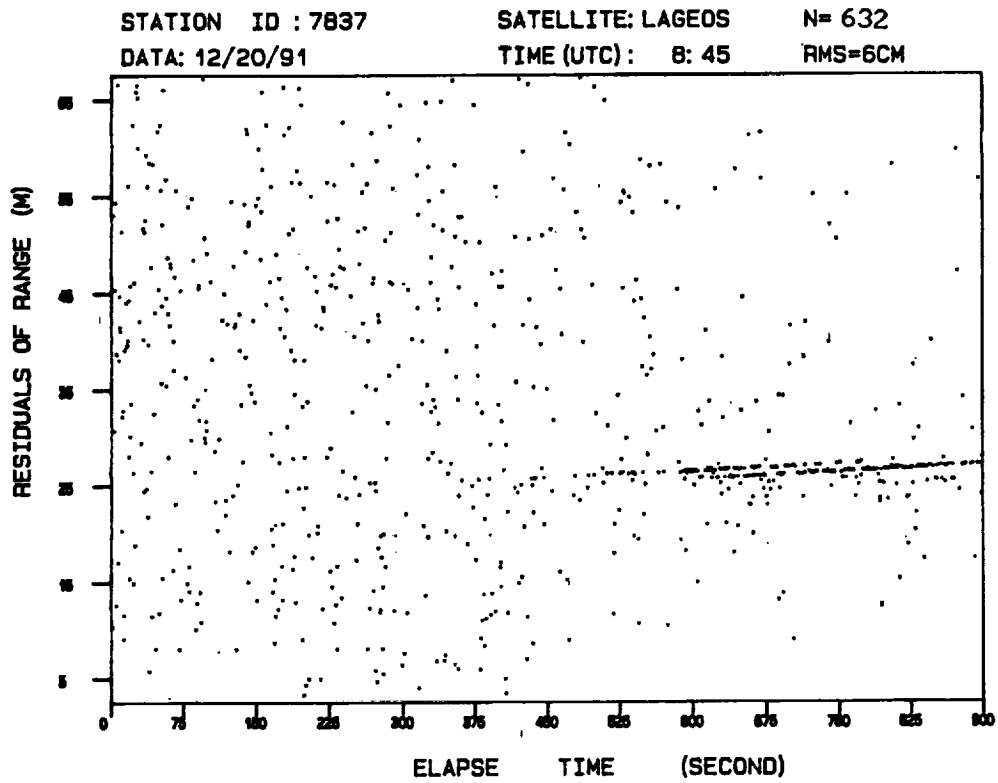

Fig.3 Daylight tracking to Lageos on December 20,1991

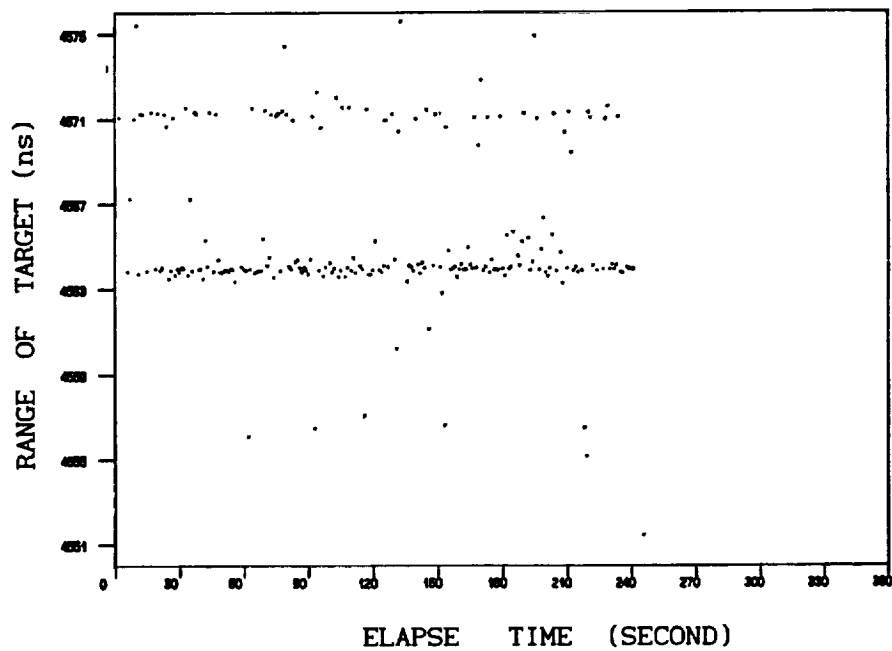

Fig.4 Ground target calibration on May 9,1992
 with 10 psec laser train and a SPAD receiver

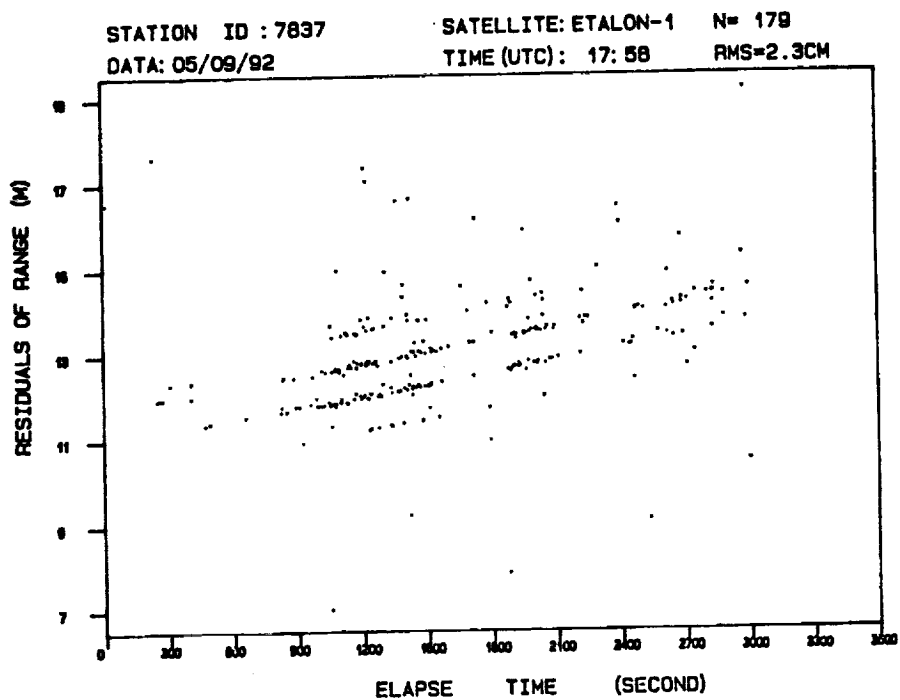
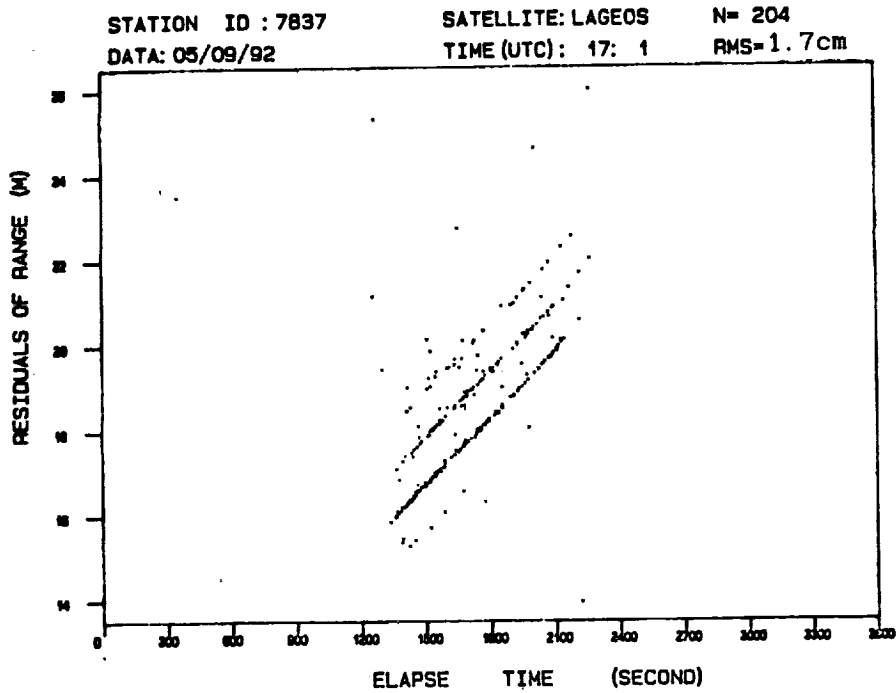

Fig.5 Results of ranging to Lageos and Etalon-1
 with a 10 psec laser and a SPAD receiver (May 9, 1992)
 Single shot accuracy(rms): 1.7--2.3 cm

STATUS-REPORT on WLRS

R. Dassing, W. Schlüter
Institut für Angewandte Geodäsie
Fundamentalstation Wettzell
D - 8493 Kötzing

U. Schreiber*
Forschungseinrichtung Satellitengeodäsie
Fundamentalstation Wettzell
D - 8493 Kötzing

Abstract

The Status-Report of WLRS gives an overview of its set up and the developments necessary to make the system operational.

1 History

After setting up the new Wettzell laser ranging system WLRS in the year 1989 the system got its first successful returns from LAGEOS at 29th January, 1990 (see table 1). As these returns were not calibrated they were only of "engineering use". The system showed that it was able to track to Etalon-type satellites and to METEOSAT P2. Before the first attempts to the moon were started the system was set up to a reliable and calibrated state. In order to guarantee continuous observations from Wettzell a co-location between SRS and WLRS has been carried out. The old SRS-system is now replaced by WLRS.

At the beginning of 1991 WLRS started to track on a routine basis to the satellites LAGEOS, ETALON-1 and ETALON-2. During the first six month of year 1991 the WLRS-System was operated by one shift mostly during night times. Since 1st July 1991 there were enough educated observers to track 24 hours a day. This can clearly be seen in the amount of observed passes (see table 1). The number of returns per LAGEOS-pass ranged from several hundred up to 6000. At the end of 1991 the operators had enough experiences to track AJISAI, STARLETTE and ERS-1 satellites.

The first (calibrated) measurements from the moon were obtained in July 1991. In November 1991 a series of 52 echos from the moon could be measured, which resulted in one normalpoint.

*Technische Universität München, Arcisstr. 21, D - 8000 München 2

Jan., 29th, 1990	First echos from LAGEOS
Feb., 21st, 1990	First echos from ETALON-2
Feb., 23rd, 190	First echos from METEOSAT P2
Oct., 1990	First echos from APOLLO-15 reflector
Oct.1990 - Jan.1991	Collocation between SRS and WLRs
Feb.1991 - Jul.1991	Operational tracking system to LAGEOS, ETALON-1 and ETALON-2 during night time.
Jul.1991 - today:	Operational tracking system to <i>all</i> satellites and to the moon on 24 hours per day.

Table 1: Highlights of setting up WLRs

Month	Lunar	LAG	E-1	E-2	AJI	STARL	ERS1	sum
01'91	-	19	-	4	-	-	-	23
02'91	-	4	-	1	-	-	-	5
03'91	-	2	3	2	-	-	-	7
04'91	-	7	10	7	-	-	-	24
05'91	-	4	9	4	-	-	-	17
06'91	-	13	7	16	-	-	-	36
07'91	1	57	26	19	-	-	-	102
08'91	-	64	33	27	-	-	1	125
09'91	-	49	19	19	-	-	2	89
10'91	-	60	8	17	-	-	-	83
11'91	1	18	9	6	-	-	-	33
12'91	-	22	1	2	-	-	-	25
01'92	-	30	1	3	14	-	-	46
02'92	-	32	8	7	16	-	-	63
03'92	-	39	6	9	29	3	3	86
04'92	-	38	4	6	20	-	4	72

Figure 1: Number of passes during 1991 and 1992 of WLRs.

2 Developments

The following modifications and extension were carried out:

- WLRs is controlled by a HP1000/A900 computer. The observations during 24 hours a day restricted the computation time for non realtime tasks. Therefor the processing capacity was extended by an UNIX-based computer HP9000/835. The A900 and the HP9000 were connected to the local area network (LAN) of the Wettzell station.
- To track low orbiting the realtime software had to be modified:
 - To drive the telescope within its full capability under computer control the telescope driving process needed to be replaced.
 - An algorithm was written to drive the telescope "smoothly" into a pass which already has passed the tracking horizon.

- The transmit/receive switch between outgoing and receiving laser pulses is realized as a rotating mirror with two holes. To fire the laser with 10 Hz the mirror must rotate with 5 Hz. To track low orbiting satellites the software to ramp up and control the rotating frequency of the T/R-switch up to 10 Hz was replaced.
- To track low orbiting satellites a 'time bias' was built into the realtime software. This 'time bias' moves the current epoch for the calculations of azimuth, elevation and range.
- During winter 1991/1992 the analysts of the University of Texas and Bendix found a sudden range bias of about 1.75 m. This was caused by the replacement of an amplifier of MCP.
The reason was found in the dead time of the detection electronics. The electronic needs about 68 ns to be able to detect the realtime calibration pulse after the detection of the start pulse of the laser. This means that the calibration return must take more than 68 ns to be recorded by the event timer. As the return signal from the calibration retro was very close to 68 ns it was not obvious that the electronic detected the "dead-time" instead of the real calibration echo. Now, the calibration return moved away from this critical region to avoid any collisions.
- The quicklook-data generation was replaced by a normal point generation. An orbit fitting algorithm is used.
- Experiments in 2-color ranging have been carried out by measuring several LAGEOS-passes simultaneously in green and infrared [Schreiber et al.].

3 Summary

After setting up WLRS in 1989 some essential modifications were carried out:

- High data acquisition rate (up to 6000 Returns per LAGEOS pass);
- Normalpoint precision of 3 - 5 mm (BEFC);
- A laser ranging system which can track all targets — from ERS-1 to the moon.

4 References

[Schreiber et al.] U. Schreiber, K.H. Haufe, R. Dassing, "Measuring Atmospheric Dispersion With WLRS In Multiple Wavelength Mode", published in this proceedings

**GROUND BASED LASER RANGING
FOR SATELLITE LOCATION**

by

**G. C. Gilbreath
Optical Systems Section
Naval Center for Space Technology
Naval Research Laboratory**

and

**Harold D. Newby
Malabar Test Facility
Phillips Labs (AFMC)**

ABSTRACT

In this article, we describe a new satellite laser ranging capability which is a joint effort between the Naval Research Laboratory and Air Force Optical Tracking Facility at Malabar, Florida. Initial measurements off LAGEOS indicates that uncorrected radial range rms values of 8mm are readily achievable. Number of photoelectron counts are on the order of 180 which are off by an order of magnitude from predicted values.

I. INTRODUCTION

A new SLR capability designed and implemented by the Naval Research Laboratory is now operational at the Air Force Optical Tracking Facility in Malabar, Florida. The configuration is based on the monostatic design utilized by a number of the NASA systems in the geoscience network. The laser itself is more powerful than those used by the NASA network and electronics are somewhat different. The system was designed for experimental efforts in tracking unenhanced satellites (those satellites without retroreflectors), plumes, and other targets which may or may not have large laser ranging cross sections.

II. CONFIGURATION

A. Tracking & Acquisition:

Tracking and acquisition was done by the optical tracking facility at Malabar, Florida. Malabar's facility provided a bistatic optical acquisition capability when tracking in "terminator" mode. In this mode, a platform is sunlit but the tracking station is in the dark. The initial acquisition is done passively with the 1.22 m aperture telescope. Once trained on

the satellite in question, the 0.61 m aperture telescope can track the target within 5-10 μ R of accuracy. All vectors, offsets, and tracking is done under computer control using a MicroVax III. Video recordings of a laser ranging event is made in addition to a digitized record of tracking vectors and related offsets.

The transmitter/receiver design is monostatic although acquisition is bi-static. Once the 0.61 m telescope is trained on the target, laser ranging commences. A diagram of the overall method is shown in Figure 1.

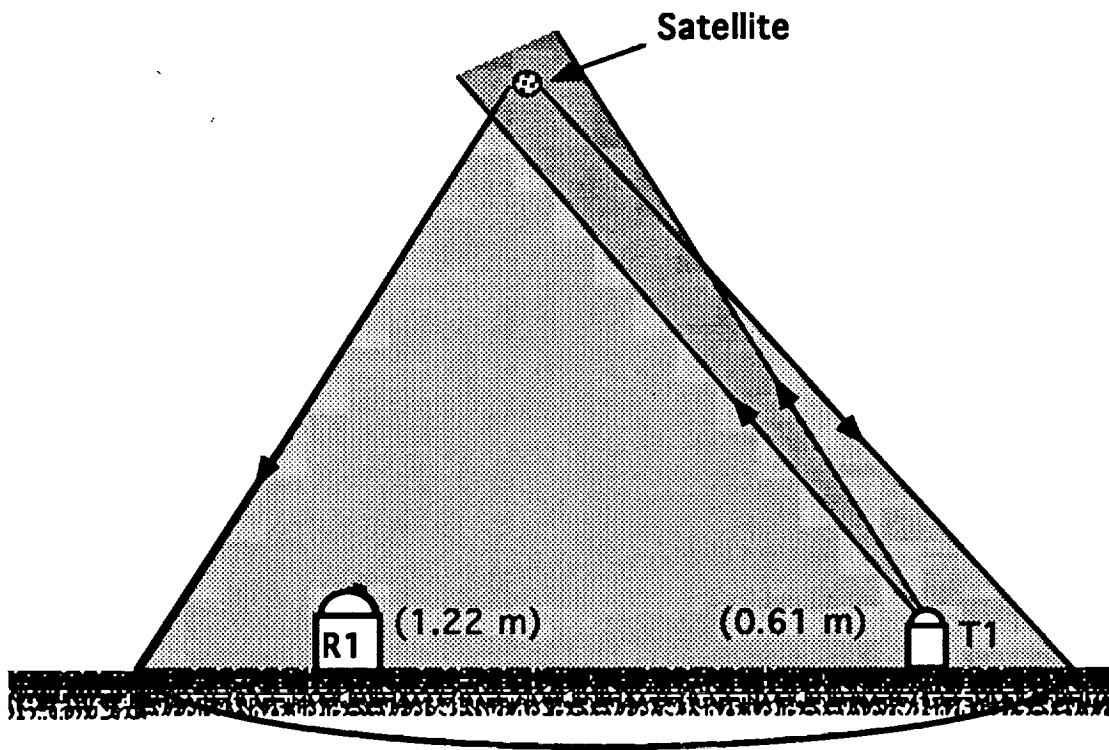

FIGURE 1. NRL/Malabar Satellite Laser Ranging Acquisition Diagram. Initial Acquisition is bistatic when platform is acquired in "Terminator Mode". Once acquired by R1, T1 tracks. The laser ranging T/R is monostatic using T1.

The return signal is collected by the telescope and directed back through the optics where the light is directed to a MCP/PMT using a specially designed annular mirror. The return signal, if strong enough, is split, where part is sent to the time interval counter, and part is sent to a wideband oscilloscope (4Ghz) for waveform capture. An overall system block diagram is shown in Figure 2.

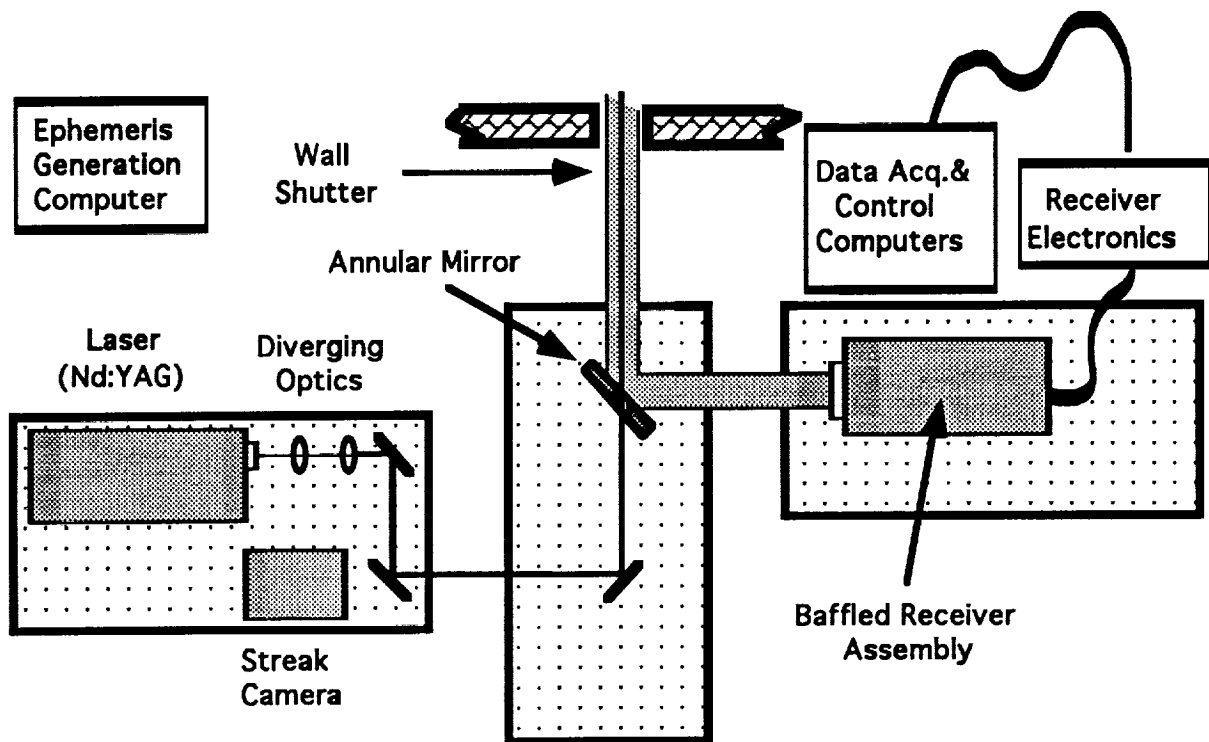

FIGURE 2. NRL/Malabar Satellite Laser Ranging Block Diagram. Configuration shows laser and transmit optics directed through an annular mirror; returned signal is directed via the mirror to the baffled receiver assembly where time differences and waveforms are recorded digitally for off-line analysis.

B. Transmitter:

The laser was designed for the effort by Continuum and is a doubled-YAG, Q-switched, mode-locked laser. The cavity design is "active-active" in that a pulse slicer is used rather than a dye to select desired modes. The configuration includes an oscillator stage and two single-pass amplification stages. The laser provides 300 mJ per pulse in a 250 ps pulsewidth. The pulse repetition rate is 10 Hz. The beam divergence is approximately 10 times the diffraction limit.

Initial alignment in the active-active mode has proven to require careful adjustment. For this reason, a streak camera is configured into the testbed. It was found that initial diagnostics are required at start-up but good alignment is maintained throughout a given ranging session.

Scattered infrared light is focused onto a PIN detector and the output is directed through a constant fraction discriminator (CFD). The signal is then split and sent to a SR 620 time interval counter and to the IRIG board in the HP 9836 Controller, which time-tags the event.

C. Optics:

Adjustable "zoom" optics are installed to vary the divergence of the beam through computer control. The range of variability is designed for an output at the antenna of $10\mu\text{Rad}$ - $100\mu\text{Rad}$.

A special annular mirror was designed such that the transmitted beam passes through a 4.57 cm hole in the 20.32 cm mirror. The return beam is collimated by the telescope to present a ~ 11.4 cm beam to the flat. The return beam is then directed to the baffled receiver assembly.

D. Receiver:

The return signal is directed through a 1 m focal length lens to a mirror which can be switched in and out of the optical path. When in place, this mirror directs the light toward a Fairchild intensified CCD which enables verification of proper optical alignment of the receive optics. When this mirror is switched out, the beam is focused onto a 500mm pinhole and directed into the gated ITT F4129 PMT/MCP detector. This detector has a quantum efficiency of 16% with a gain of $\sim 10^6$ at 532nm. The detector itself is gated to reduce noise using a programmable delay/width generator. The gatewidth can vary from several hundred nanoseconds to $10\ \mu\text{s}$.

The output from the PMT is amplified, inverted, and passed through a constant fraction discriminator. The output is time-tagged by the SR 620 time interval counter and the difference stored in the computer. A portion of the output is also directed to a Tektronix SCD 5000 4 GHz wideband oscilloscope which digitizes and stores the waveform for later analysis. A block diagram of the electronics is shown in Figure 3.

III. LAGEOS CALIBRATION

The system was calibrated by ranging off LAGEOS for a series of passes. Radial RMS ranges (uncorrected) were estimated to be $\sim 8\text{mm}$ using the system. Detected photoelectron counts were on the order of 50-190. We initially estimated returns on the order of 1100 p.e.'s. It is possible that the divergence convolved with pointing accuracy has a greater error than anticipated. However, scatter loss is most likely to have been the major contributor to the lower returns.

IV. CONCLUSION

The Naval Research Laboratory and the Air Force Optical Tracking Facility have installed a new satellite laser ranging

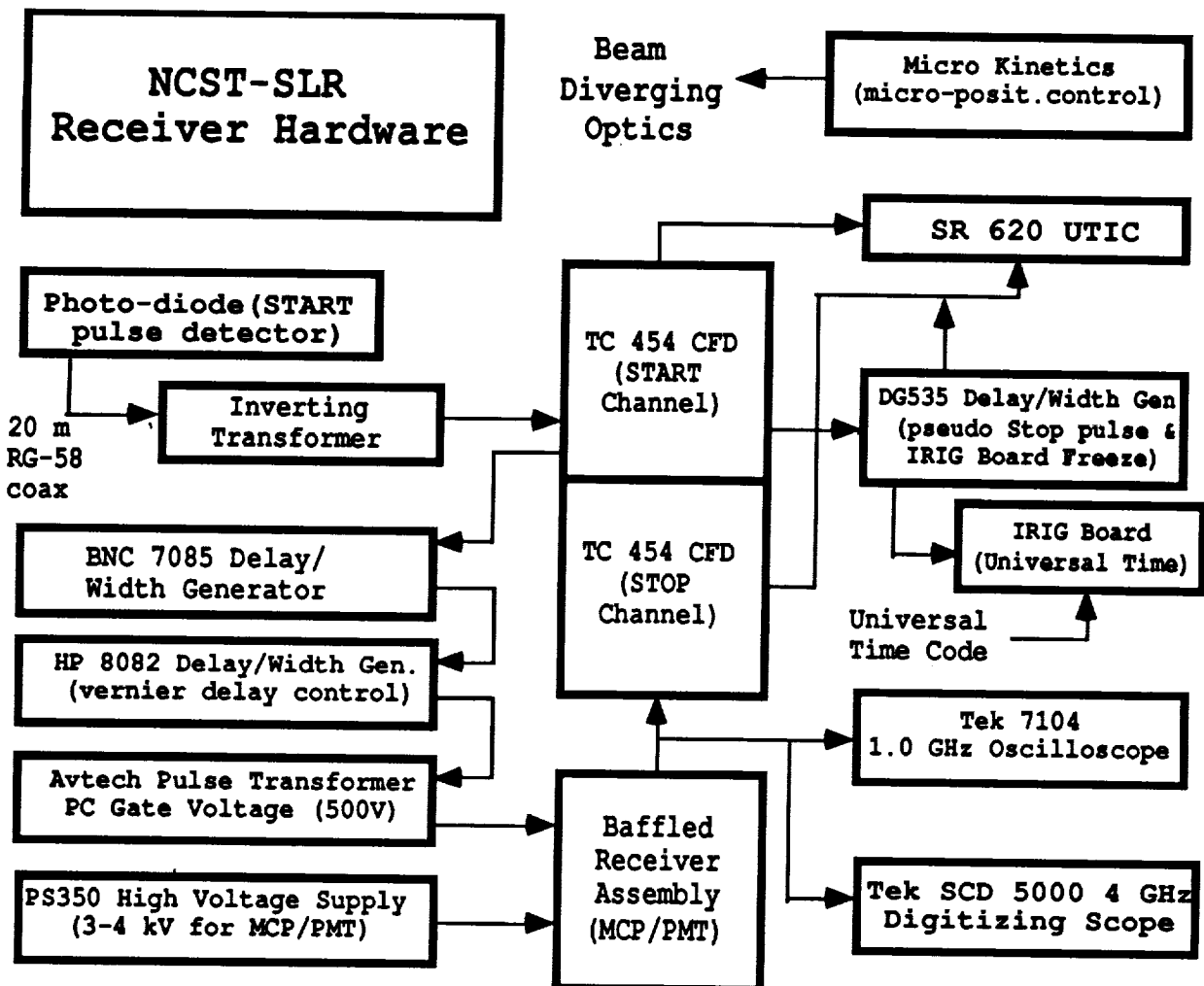

FIGURE 3. NRL Satellite Laser Ranging Receiver Hardware Block Diagram.

capability in Malabar, Florida. The system is based on the NASA monostatic designs used by MOBLAS and other ground sites. The laser itself is a 300 mJ/pulse, 250 ps, 10Hz, Q-switched, mode-locked, active-active design. The detection system includes a gated ITT F4129 PMT/MCP detector and a 4 GHz wideband Tektronix digitizing oscilloscope.

Initial measurements off LAGEOS indicates that an 8mm uncorrected radial range rms is easily achievable. However, actual p.e. counts are smaller than predicted by an order of magnitude. This may be due to larger than anticipated divergence and/or to back scatter.

Future efforts will require direct measurement of the divergence in the far-field using the "dithering" technique common to MOBLAS users. Corrections to divergence can be made using the computer-controlled zoom optics in the transmit

optical train. Anticipated experiments will include ranging off of platforms which may not have enhanced laser ranging cross sections and ranging off plumes.

V. ACKNOWLEDGMENTS

We would like to thank John Degnan, Tom Varghese, Tom Zagwodski, and the other NASA personnel who were so generous with their time and advice. We would also like to acknowledge the MacDonal Observatory, and especially Jerry Wiant whose suggestions were invaluable.

We would especially like to acknowledge both the NRL and Malabar teams, without whose the dedication, hard work, and creativity, the system could not have been designed, integrated, and calibrated in such a timely manner, including W. C. Collins, W. L. Lippincott, J. Pirozzoli, T. Murphy, S. Peterson, A. Clement, J. Kobesky, R. Dasenbrock, R. Betz, T. Knox, M. Baciak, P. Patowski, and R. Orcutt.

NEW PROGRESS OF RANGING TECHNOLOGY AT WUHAN SATELLITE LASER RANGING STATION

Xia Zhizhong, Ye Wenwei, Cai qingfu
Institute of Seismology State Seismological Bureau
430071 Wuhan China

ABSTRACT

A satellite laser ranging system with an accuracy of the level of centimeter has been developed successfully at the Institute of Seismology, state Seismological Bureau with the cooperation of the Institute of Geodesy and Geophysics, Chinese Academy of Science. With significant improvements on the base of the second generation SLR system developed in 1985, ranging accuracy of the new system has been upgraded from 15cm to 3-4cm. Measuring range has also been expanded, so that the ETALON satellite with an orbit height of 20,000Km launched by the former U. S. S. R. can now be tracked.

Compared with the 2nd generation SLR system, the newly developed system has the following improvements:

(1) A Q modulated laser is replaced by a mode-locked YAG laser. The new device has a pulse width of 150ps and a repetition rate of 1-4pps.

(2) A quick response photomultiplier has been adopted as the receiver for echo, for example, the adoption of MCP tube has obviously reduced the jitter error of the transit time and therefore has improved the ranging accuracy.

(3) The whole system is controlled by an IBM PC/XT Computer to guide automatic tracking and measurement. It can carry out these functions for satellite orbit calculation, real-time tracking and adjusting, data acquisition and the preprocessed of observing data etc., the automatization level and reliability of the observation have improved obviously.

INTRODUCTION

Satellite laser ranging (SLR) is a new measurement technology established with the advancement of laser, optoelectronics, computer, and space science. It has been widely applied in geoscience. Its observing date have already been used in many scientific fields such as geody-

namics, geodesy, astronomy and earthquake prediction.

It has especially shown its importance in monitoring the movements of global plates and regional crust, determining geocentric coordinates, and studying of earth rotation parameters and gravitational field model. The 2nd generation SLR system finished in 1985 at the Institute of Seismology. The system has a measuring range of 8000Km and the accuracy of 15cm. In order to upgrade the equipment from 2nd to 3rd generation. So that the observing data of Wuhan SLR station can meet the need of monitoring crustal movements and the research of earth rotation parameters and solid earth itself, the Institute of Seismology and Institute of Geodesy and Geophysics established cooperative relation.

The 3rd generation system tracked satellite AJISAI of Japan and Lageos of US successfully several times in June 1988. After the preprocessed of observing data, the accuracy of single shot attained 5—7cm. Since August 1989, the quick-look data of the ranging results have been sent to GLTN of NASA. The accuracy of Lageos observing data of Wuhan SLR station back from GLTN is also about 5-6cm.

In April of 1990, F4129 micro-channel plate (MCP) is used to replace PM2233B photo multiplier and the accuracy reaches 3-4cm. At the same time ETALON-2 and ETALON-1 satellite with an orbit height of 20,000Km launched by the former U. S. S. R. in 1989 were also observed.

Measuring Principle of System and Performance of the Individual Parts

The ranging principle of the Wuhan SLR system is as follows: the ephemeris (provided by GLTN or CSR of Texas University) is input into an IBM PC computer before observation, in order to calculate and interpolate the satellite orbit. A real-time clock in the computer sends out a series of order signals to control the automatic tracking of the mount, to shoot laser beam, to pre-set range gate, to correct the pointing direction of telescope and range gate in real time and to collect observing data. At the moment of shooting laser the main pulse is sampled as the open signal for time interval counter. The echo from the retroreflectors of the satellite is received by a telescope with an aperture of 60cm. The optical signal is converted to an electronic pulse by MCP tube and then amplified to close the time interval counter and the time interval measurement is completed. Meanwhile, observing data is collected by the computer. The whole measuring process is shown on the computer display. Observing object, calculating satellite position, or ways of interpolation and measurement can all be selected on the menu. Fig. 1 and Fig. 2 show the telescope and computer, control and electronic measurement system respectively. Table 1 is the performance of the main parts in the system.

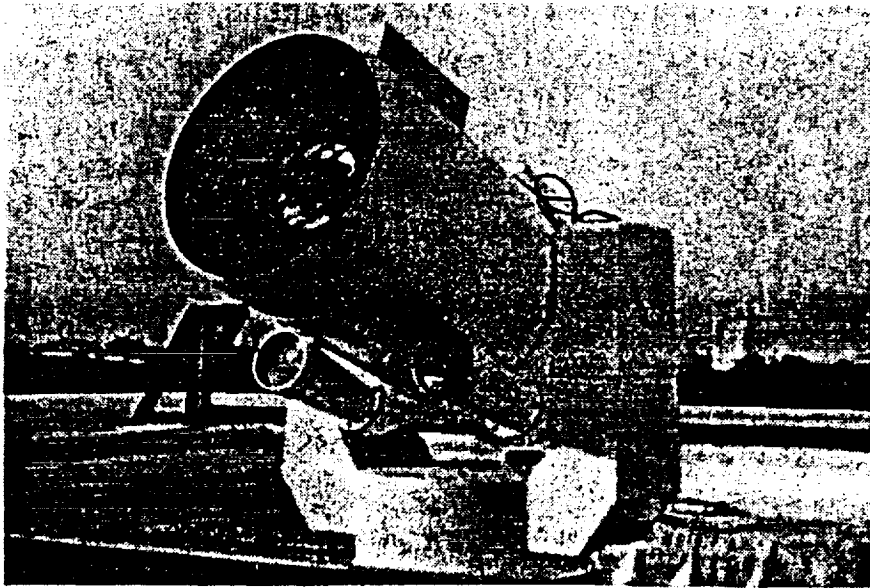

Fig. 1 The mount of Wuhan SLR system



Fig. 2 Receiving electronic equipment, computer and clock subsystem

Table 1 Specification of the satellite laser ranging system at Wuhan

Subsystem	Specification
Mount	
Configuration	elevation-azimuth
Tracking velocity	18 arcsec—0.5° per second
Synchronistic inductor	resolution 1 arcsec
Drive	DC torque motors
Orthogonality	±4 arcsec
Laser	
type	Nd:YAG
Wave length	0.532μm
Energy	50mj
Pulse width	150ps
Repetition	1-5pps
Receiving telescope	
Type	Cassegrain
Diameter	60cm
Field of view	1'-6' or 1°(use for sighting satellite)
Filter	1nm
Transmitting telescope	
Type	Galilean
Diameter	10cm
Beam divergence	0.6'-3' can adjustable
Sighting telescope	
Diameter	15cm
Field of view	3°
Receiving electronics	
PMT	ITT F4129 MCP
Amplifier	H/P 8447 D
Discriminator	Canberra 1428A
UTC clock	
Type	Cesium H/P 5061A
Stability	1×10 ⁻¹²
Accuracy	2μs
Time interval counter	
Type	5370B
Resolution	20ps
Micro computer	IBM PC/XT

Main Improvements

1. Nd : YAG ultra-short pulse mode-locked laser is used

An active and passive mode— locked laser with Nd : YAG as laser material is used in the new SLR system. Fig. 3 is block diagram of laser. Infrared light output of 100 mJ in energy, 1.06 μ m in wavelength, and 150ps in pulse width is got from laser with one stage oscillator and three stage optical amplifier. It is converted to green light of 50mJ in energy, 532nm in wavelength and 1-4pps adjustable in repetition rate. Compared with the Q modulated device(4.5ns in pulse width, 0.25J in energy) used in the 2nd generation system, The new laser improved the ranging accuracy, because the pulse width is reduced greatly Table 2 shows the comparison of ranging accuracy between adopting Q modulated device and mode-locked device, while other conditions are the same.

Table 2. The Comparison of ranging accuracy between Q modulated and mode—locked laser from LA-GEOS

DATE	TIME	OBS	Wuhan RMS(cm)	GLTN RMS(cm)	LASER
1985. 08. 02	23:44	103	13.9		YAG Modulated Q
8. 03	22:20	370	15.8		
8. 14	21:26	131	14.6		
8. 16	22:21	105	15.4		
9. 11	22:01	280	14.9		
9. 28	20:02	320	14.7		
10. 05	21:03	101	16.1		
10. 07	21:50	170	15.7		
1989. 11. 27	18:50	471	5.7	5.1	YAG Mode-Locked
11. 28	17:34	431	5.7	5.1	
11. 28	21:07	303	5.7	6.5	
12. 01	17:04	144	6.1	6.5	
12. 01	20:28	483	6.3	6.5	
12. 02	19:04	176	7.3	5.1	
12. 03	17:44	330	7.5	5.3	
12. 03	21:18	438	6.7		

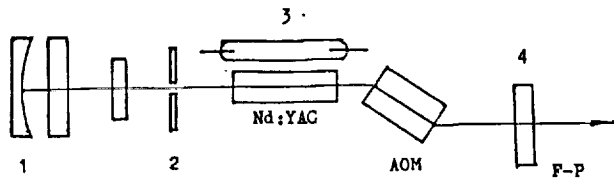

High Repetition Rate Ultra-short Pulse Oscillator
 1-Rear mirror contacted by dye cell with circulating system. 2-Transverse mode selecting aperture.
 3-Xe flash lamp. 4-Front mirror.

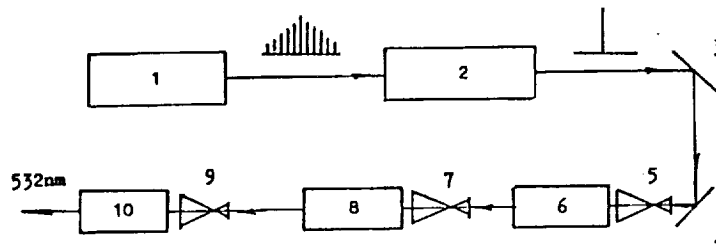

1-Ultra-short pulse oscillator. 2-Single pulse selector.
 3,4-45° mirrors. 5,7,9-Beam expanders. 6-First stage of amplifier.
 8- Two stage of amplifier. 10-Harmonic generator.

Fig. 3 Schematic Diagram of Repetition Rate Ultra-short Pulse Laser System

2. Improvement of opto-electronic detector PM2233B photomultiplier is employed as detector for main and echo pulse in the 2nd generation SLR system, the transit time of electron in the whole tube is relatively long so the jitter error will become very important for precise ranging. In order to overcome this shortcoming, F4129 MCP photomultiplier with 1ns transit time is used for detecting echo in the 3rd generation system. The jitter error is sharply reduced because the distance between the cathode and micro-channel plate is just 0.6μm. Table 3 shows the observing results before and after the photomultiplier is replaced. Data processing by GLTN, Delft University and ourselves, all show that the ranging accuracy has upgraded from 5-7cm to 3-4cm.

Table 3. the Observing results before and after the photomultiplier is replaced from LAGEOS

DATA	AOS	LOS	OBS	Wuhan RMS(cm)	GLTN RMS(cm)	DELT1 RMS(cm)	PMT
SAT. LAGEOS							
90. 3. 6	17:55:15	18:17:48	81	8.1	5.6	6.4	PM 2233B
3. 7	16:24:58	16:51:52	210	7.1		6.4	
4. 4	13:32:14	14:11:08	308	8.4		7.2	
4. 12	13:11:49	13:50:55	47	8.8	7.8	8.0	
4. 13	15:25:13	15:56:08	265	7.5	4.7	6.1	
4. 19	14:16:44	14:57:38	675	6.4	5.4	6.1	

4.25	13,04:01	13,44:19	312	4.5	4.4	4.9	F4129 MCP
4.26	11,48:11	12,19:58	346	6.3	6.1	4.9	
4.26	15,18:14	15,47:42	387	4.6	4.8	4.9	
5.4	11,49:50	12,00:50	40	4.1	3.7	3.5	
5.4	15,01:39	15,26:16	274	3.9	5.0	3.5	
5.5	13,36:30	14,11:07	643	3.8	3.2	3.3	
5.6	12,17:38	12,41:51	123	3.9	2.9	3.3	
5.9	11,50:05	12,06:31	252	4.0	3.4	3.3	
5.17	14,54:44	15,16:12	355	3.8	2.1	1.6	
5.18	13,26:49	14,05:00	1050	3.8	2.2	2.8	
5.19	12,07:34	12,37:50	530	3.8	2.2	2.0	
5.24	12,22:27	12,54:50	630	3.6	4.4	2.8	
5.25	14,37:25	14,55:54	163	4.1	2.3	2.0	
5.27	12,07:14	12,24:11	114	3.8	2.0	2.0	
6.1	12,02:29	12,35:54	491	3.8	1.3	1.8	
6.8	13,13:31	13,31:57	294	3.6		1.8	
6.10	13,54:12	14,16:18	164	4.3		1.8	

3. Automatization and reliability greatly improved with the use of IBM personal computer.

Though the 2nd generation system at Wuhan SLR station has realized automatic track for the first time in China. "Automatic" only means the numerical guiding of the mount since only two 8-bit single board micro-computer is used for real-time control while orbit elements of the satellite (one set for every 20 second) is calculated by VAX-750 computer and is input from Keyboard manually. Heavy work load, low information convey speed, frequent handling error are among the shortcoming. the 3rd generation SLR system adopts IBM PC as its control center. Real-time clock range, gate controller, data acquisition and laser shooting controller, etc. which are originally in the instrument cabinet are extended in programmable functions and are reduced in volume, so that they combined on two extending boards to be installed in the extension slot of IBM PC computer. With these change, the structure is compacted and reliability raised. Software regarding ephemeris, data processing, numerical track guiding, software managing, etc. are all transplanted to IBM PC computer. While working, the telescope is automatically guided towards the satellite by the track control part with the calculating result from ephemeris. In order to improve tracking accuracy, tracking parameters (time, azimuth, elevation) can be displayed and corrected in real time during the observation. Observing results and o-c difference are also displayed in both digital and graphical ways, so that the operator can understand working state and correct parameter to improve hit rate. Once observation end, the preprocessing is selected to analyze ranging data. By the manner of the menu

the operational course are simplified greatly. These improvements decreased the misoperation and raised the efficiency. Fig. 4 shows the display of some parameters on computer screen during the operation.

1990/05/14	11:50:20	Clock	12:11:20	SATELLITE:	
TRACK: ON		ΔT	00063ms	LAGEOS	
SCALE: 1		LASER ON	2/s rate	KEY: ON	
				MP: 00243	
AZ	133:23:54	HI	77:54:27	RAN	39805.7
ΔA	00015	ΔH	-00007	ΔR	0003.0
UA	00959	OH	-00058	GN	0006.0
O-C	-00001	O-C	00002	O-C	0004.5
	00040		00020		

Fig. 4 The display of some parameters on computer screen during the operation

In addition, other improvement are also carried out e. g. 5370 B time interval counter is instead of old one and stability of laser output and the accuracy of mount pointing are also improved. We are also striving to realize daytime observation and to improve other performance of system to better the use of SLR technology for geoscience research.

Reference

1. Xia Zhizhong, Ye Wenwei, Cai Qingfu. "A satellite laser ranging system for tracking LAGEOS" proceedings of China- United states symposium on crustal deformation and earthquake, 1985 Wuhan China.
2. John J. Degnan "Satellite Laser Ranging; Current status and Future Prospects" IEEE Transactions on geoscience and remote sensing, Vol. GE-23 No. 4 July 1985.
3. Ye Wenwei, Xia Zhizhong, Liu Hangang, "Study on Improving Ranging Accuracy in Wuhan SLR Station" in Chinese 1990. 10.
4. Guo Tangyong, et al. "A Track-Control and Data-process System for the Satellite Laser Ranging" in Chinese, 1990. 10

