

GLONASS observations at the LLR station at Grasse. Corrections related to the satellite signature effect and to the location of the center of mass.

J.F. Mangin, J.M. Torre, D. Feraudy, M. Furia, A. Journet, G. Vigouroux,
F. Barlier, C. Berger, P. Exertier.
Observatoire de la Côte d'Azur, Avenue N. Copernic, 06130 Grasse, France
Presentation given by Jean-François Mangin, F. Barlier

Abstract

On a routine basis, the Lunar Laser Ranging (LLR) station at Grasse participates to the tracking of GLONASS and GPS satellites by laser telemetry. In this context, the LLR participated to the IGEX campaign (1998-1999) with many SLR stations of the worldwide network. On the other hand, radiotracking orbit determinations were performed by several analysis centers and made available, then orbital radial corrections were determined using laser tracking data and a short-arc technique. In agreement with previous results, the mean radial correction for the entire campaign and for 8 satellites was -3.6 cm (averaging for 854 independent determinations). For interpreting this bias, several problems have been more specifically considered: the diode biases, the satellite signature effect and the correction of the center of mass. Several tests were performed with two different detection modes (single photoelectron mode and multi photoelectron mode). The results are presented. Systematic errors can be made in computing the normal points by simple averaging, but in practice the errors should be less than 1 or 2 cm. Then a correction of the center of mass was applied (the distance between the laser phase center « or the optical center of the retroreflector array » and the center of mass of the satellite). The used distance was -1.510 m but Vladimir Vasiliev sent new diagram giving a distance of -1.5416 m. In using this value, the mean radial correction for the entire campaign and the 8 satellites vanishes. However systematic biases exist for satellites separately taken for a given time but they have to be interpreted by other ways for example by considering the mismodelling of non-gravitational forces.

1. Introduction

During the International Glonass Experiment (IGEX 98, Willis et al, 1998), GLONASS and GPS satellites were tracked by SLR/LLR stations in order to qualify the GPS/GLONASS orbits determined by radiotracking. Generally the range measurements have accuracies at the centimeter level. However the case of GLONASS satellite is specific due to the large retroreflector panel.

a) First example of a low standard Glonass pass :

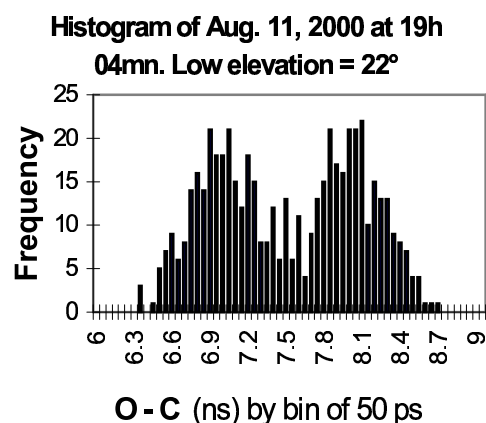
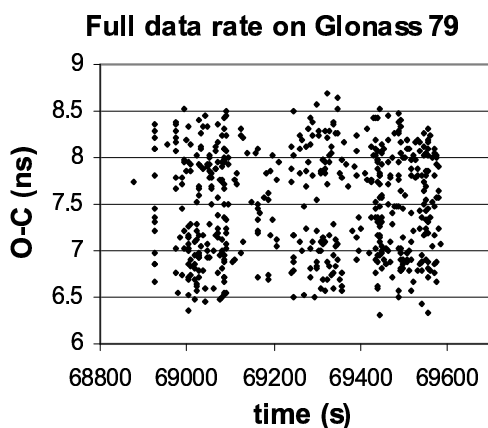

An example of laser range residuals is given in the previous figure for a low elevation. The reference orbit is the radio tracking based orbit computed at the Bern University (Ineichen et al, 2000). The histogram is symmetrical because the raw data distribution is uniform except in the central strip. This data series is in single photoelectron detection mode (returns lower than 10% of shots). The number of returns in the central part is smaller. Indeed the more numerous holes in this part of panel decrease the number of reflectors.

b) Second example of a biased Glonass pass :

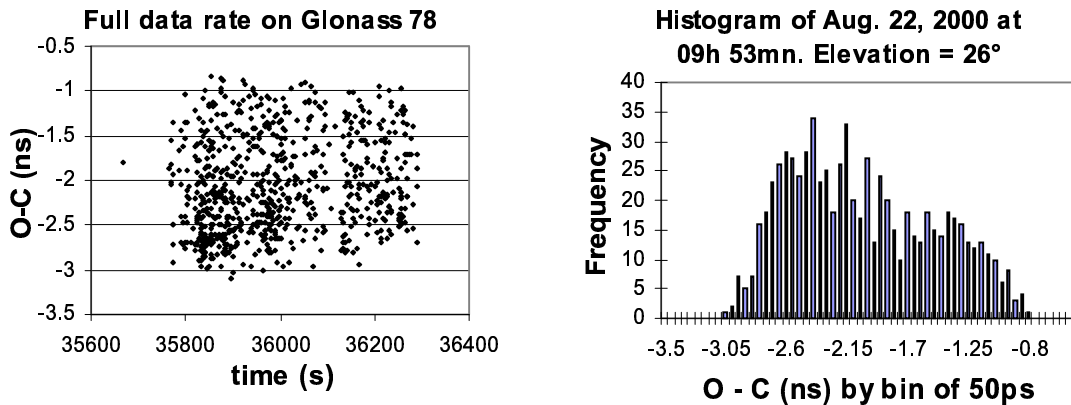

A second example is given above, when the coming back signal is much strong ; the distribution of echoes is not uniform (there are many echoes with respect to the single photoelectron detection mode) ; the two histogram bumps are asymmetric. If the normal points are computed by averaging the raw data, then the Normal Points are biased.

c) Results on the observed data dispersion on Glonass satellites :

The histograms given above, exhibit a significant dispersion, which varies as a fonction of the elevation. Several remarks can be made :

- *If the Glonass satellite is near the zenith, the total dispersion of raw data is about 600 ps corresponding to the LLR total dispersion (like a calibration).
- *If the satellite elevation is low, the dispersion increases because the angle between the laser beam and the reflector panel differs from 90°. For exemple, if the satellite elevation is 20°, the panel dispersion is 1.6 ns to which the station dispersion has to be added to get the total dispersion (2.2 ns).

In the permanent single photoelectron detection mode (less than 10% of shots), there is no bias in averaging data. When the LLR station is not in single photoelectron detection, the induced bias is a fonction of the dispersion, thus of the elevation.

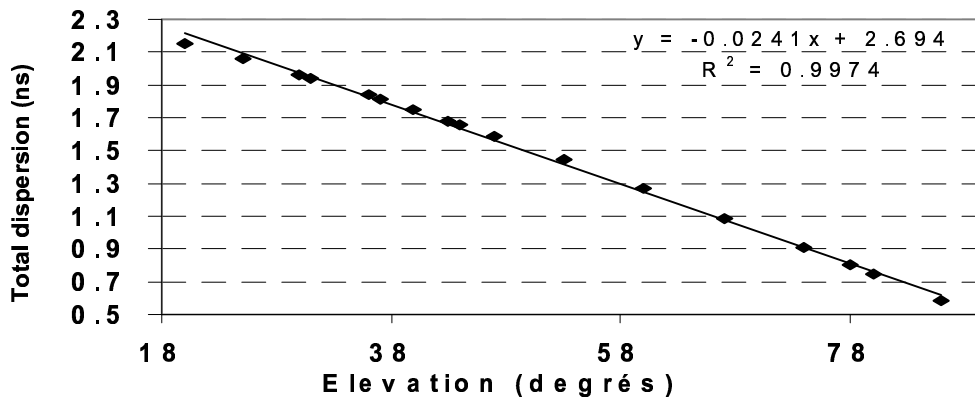

The measured total dispersion as a fonction of elevation.

2. The different sources of biases for the LLR Grasse and the Glonass satellites

The laser range residuals, with respect to the radio tracking orbit, are at the level of several centimeters up to 1 or 2 decimeters. In averaging these residuals, some biases of a few centimeters are evidenced.

The biases can have several origins :

*from the transit time in the diode.

*from the satellite signature.

*from the relative position of the satellite center of mass and the optical barycenter of the reflector panel.

a) The diode transit time biases

There are two bias possibilities :

- center-edge effect : The transit time of a photoelectron falling near the edge of the diode is **60ps greater** than the one on the diode center.

This occurs, at the LLR station, especially because the satellite velocity aberration.

- multiphotoelectron mode : The transit time of photoelectron in the diode depends on the number of photons received.

Laboratory tests have been performed to measure distance variations on internal target when increasing the return level rate (number of photoelectrons by shot).

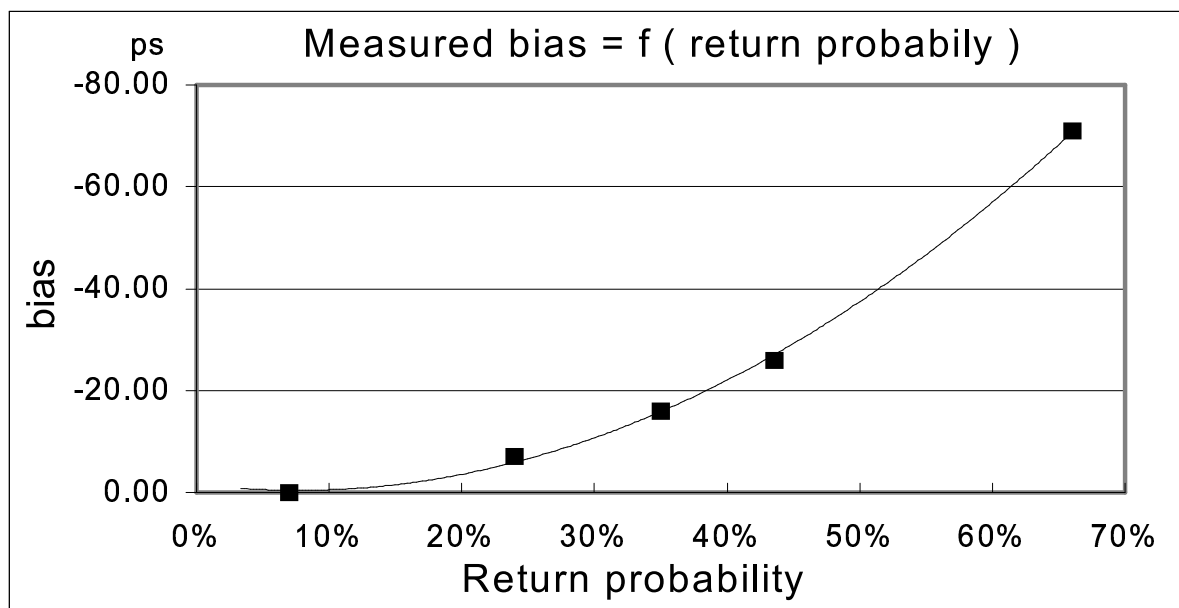

b) The Glonass satellite signature bias

The Glonass satellites signature depends on the satellite elevation, because of the temporal widening of the panel, and on the return level rate. The return probability (ratio between the number of return and the number of shots) can permit the evaluation of the return level rate from the observations ; it is assumed that the reliability of the telescope pointing permit it. Some examples are given below. These histograms show the dependence with the elevation of the satellite and with the rate of return probability.

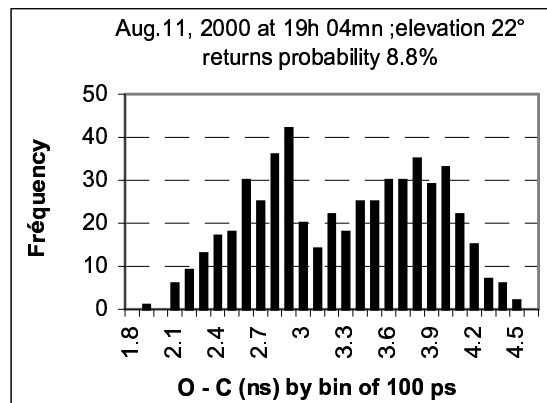
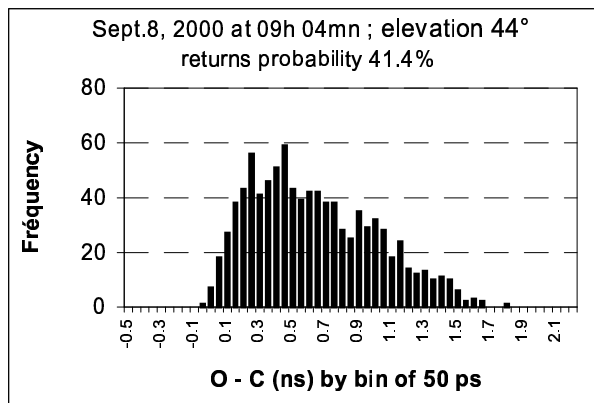
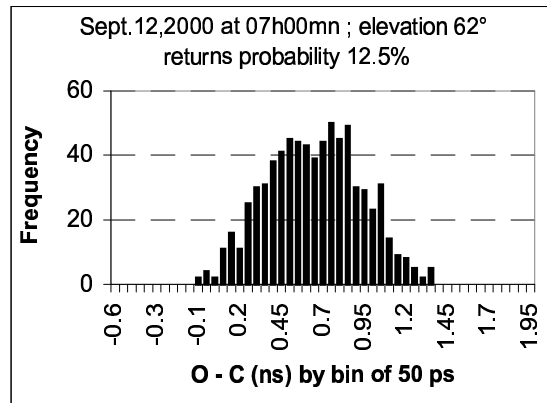
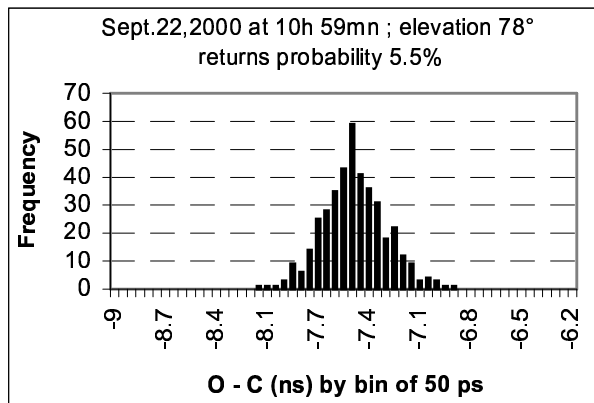

**Partial conclusions on this bias, due to the satellite signature,
in single or multi photoelectron mode**

Some conclusions can be drawn :

- *In single photoelectron mode, the probability of detecting one coming back photon from a corner cube on the rear of the panel is nearly the same that the one from a corner cube in the front. Therefore the data mean is centered on the optical barycenter of the reflectors panel.
- *In the case of 2 or more coming back photoelectrons for the same laser pulse, only the first photoelectron is dated. The others are not dated. That introduces a bias (shorter distance). Knowing the probability of returns, it is possible to know the probability to get 0, 1, 2, 3 or more photoelectrons (Samain, 1995). Therefore it is possible to estimate this introduced bias.

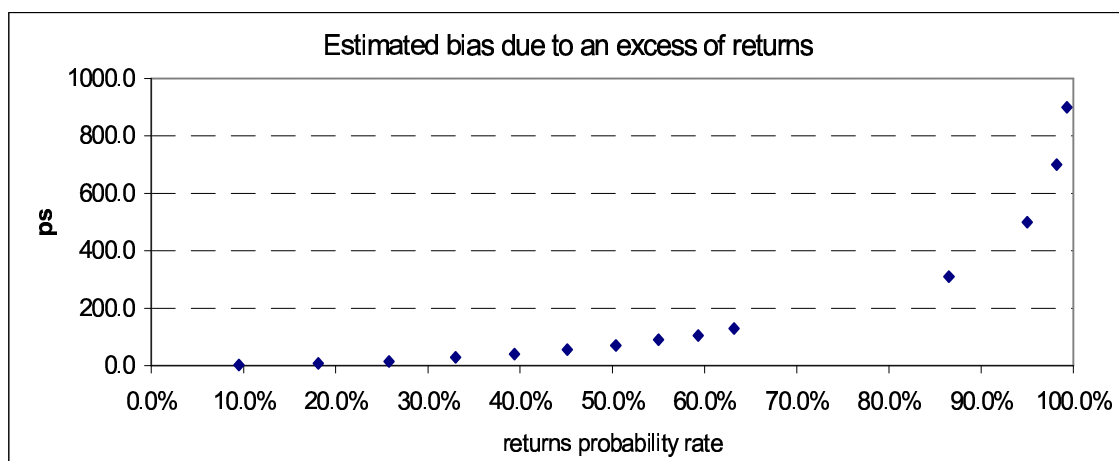

In the figure above, the biases are estimated for a dispersion of 2 ns (corresponding to a Glonass satellite to 25° of elevation). For another elevation of the satellite, the bias is proportional to the dispersion. These results have been confirmed by the following test with alternate levels of return signals, weak and strong. This diagram shows some normal points ; the square points are obtained with a weak level (single photoelectron) and the round points with a very strong level. Return probability rates are indicated on the diagram. For a very strong level (60% to 70%), the bias can reach 400 ps. For a lower level (between 10% and 20%), the bias can be 100 to 200 ps (1.5 to 3 cm).

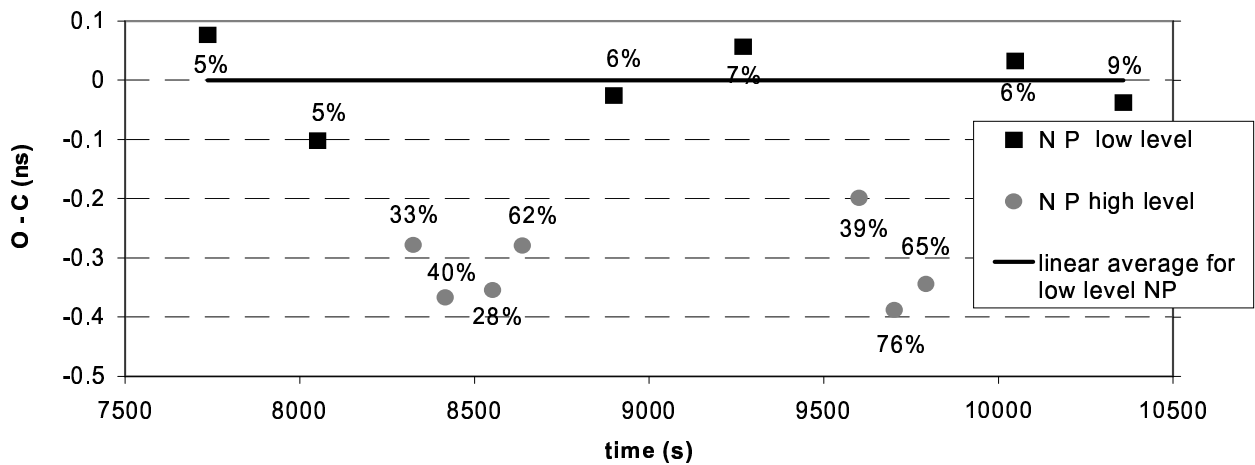

48 mn of ranging to N°79 glonass satellite

c) Bias linked to the relative positions of the satellite center of mass and the optical barycenter of the reflector panel.

The geometric diagram of the retroreflector panel is given on the opposite figure, from V.Vassiliev (1999) and transmitted to the community by H. Kunimori. A corner cube with its measurements is drawn at the top and on the left. ; at the top and on the right, the distance between the mass center of the satellite and the corner cubes faces plane is also given. The distribution of corner cubes is shown at the bottom of figure. There are no corner cube in the white area (holes in the panel). From this drawing, a new value of distance correction, between the mass center of the satellite and the optical center of the reflectors panel, can be computed :

$$-[1569.5 - (19.1 \times 1.46)] = -1541.6 \text{ mm.}$$

The difference with the previous value published in the beginning of the IGEX campaign is 3.16 cm. The global result is much more satisfactory with the new value. Indeed in using the previous value for the entire campaign

and for the eight satellites, a mean bias of -3.6cm was found for the radial correction but it vanishes with the new value as we show it in the next section.

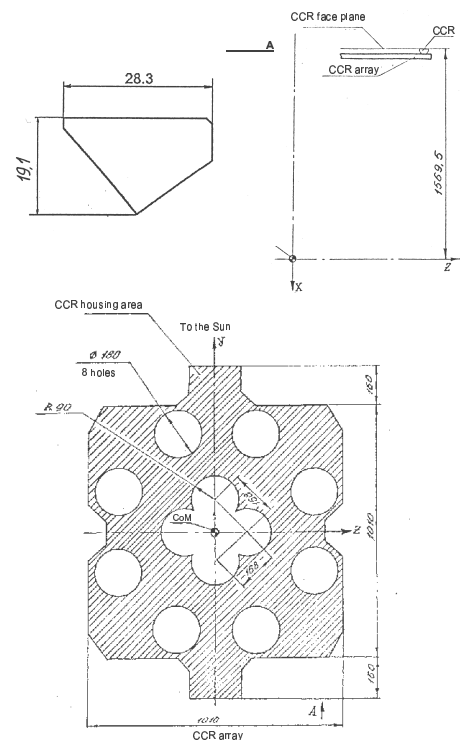

Orbital corrections of Glonass

The Glonass orbits have been determined from the radio tracking by several analysis centers in particular at the Bern University (Code orbit Ineichen et al.2000). The laser range residuals can be determined with respect to the orbit (O-C). These residuals are of the order of several centimeters as shown below in the figure for three arcs. The date and the time, when the satellite crosses the equator, are given for each arc as well as the observing stations. The origin O of the time axis corresponds to « t_0 ». The satellite ground tracks are show in the top of the figure.

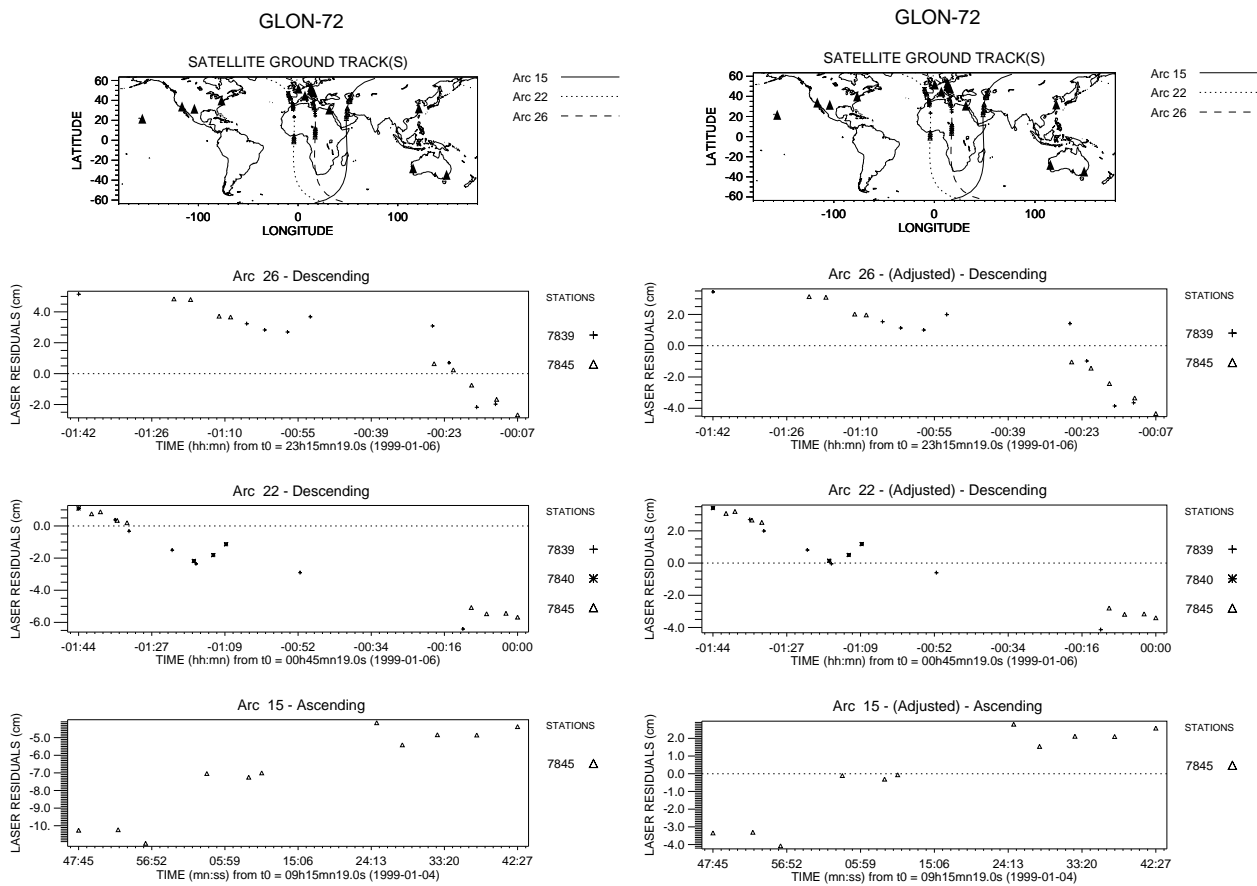

From these residuals, orbital corrections (radial, along track, normal) can be determined by a short-arc technique like used in space Geodesy for altimeter calibration or for orbit validation (Bonfond et al.1995). Here above, on the left part of the figure, are shown the laser residuals before using orbital corrections ; on the right part are shown the new residuals after using orbital corrections. From the laser range data, the radial orbit corrections together with their formal errors for eight Glonass satellites, as a fonction of time, are computed conventionally at the equator and given in the next figure (IGEX campaign). The Bern ephemerides are used as reference. The Modified Julian days 51100 and 51300 correspond to Oct. 14, 1998 and May 2, 1999 respectively. The mean value of these orbit correction is found -3.6cm in using the old center of mass correction (-1.510m) and -0.4cm in using the new value.

8 GLONASS – orbital planes 1, 2, 3

radial orbit correction (m)

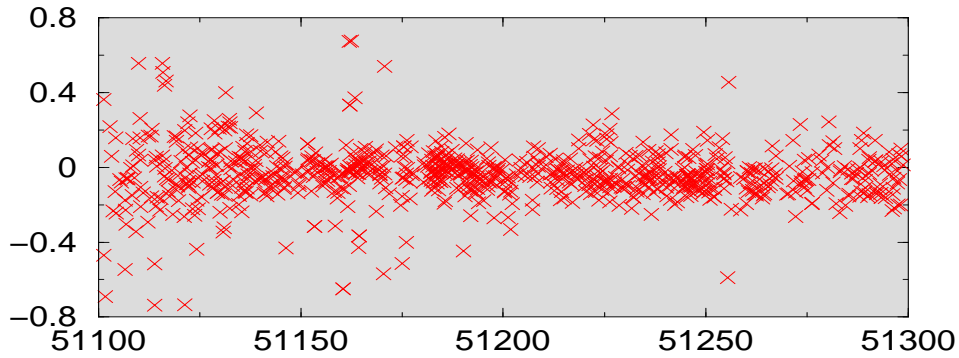

formal error (m)

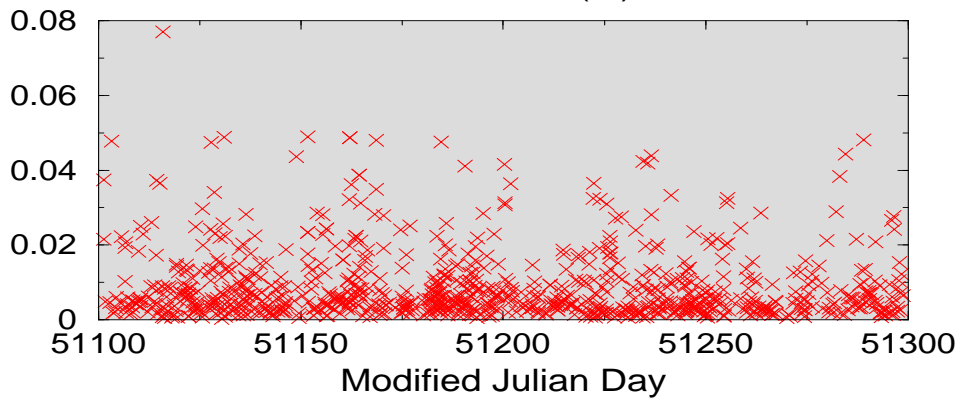

Plane	Satellite	Number of data	Mean cm	Dispersion 1σ	Slope mm/day
GLONASS					
1	68	78	-4.0 ± 0.7	6.6	-0.8
1	69	70	-1.1 ± 1.1	9.1	-1.2
1	70	108	-4.6 ± 0.7	7.5	-0.7
2	66	78	-0.5 ± 2.1	19.0	0.7
2	79	65	$+3.5 \pm 1.9$	15.4	1.1
3	62	111	-7.0 ± 0.8	8.9	-0.3
3	71	105	-3.6 ± 0.6	6.6	-0.0
3	72	96	-6.5 ± 0.7	7.5	-0.4

However systematic biases exist for the satellites when considered separately during the IGEX-98 campaign as shown above in the table. Significant biases are exhibited and have to be interpreted by considering the mismodelling of non-gravitational forces (Eanes et al.2000, Barlier et al.2001).

In the table below, the other mean orbital corrections computed at the equator from the same laser range residuals are given : the tangential and the normal corrections (**T**, **N**) with their time derivatives (**Tp**, **Np**). The mean values of **T** and **N** are small and not very significant. On the other hand **Tp** and **Np** are not negligible. They give an idea for the mean temporal variation of **T** and **N** over a short-arc (10 or 20 cm over 10 000s).

	Number of data	Mean	Dispersion 1 σ
T (cm)	51	2.1 ± 4.2	29.8
N (cm)	18	-6.8 ± 5.4	22.8
Tp (cm/s)	21	$(-1.0 \pm 0.2) 10^{-2}$	$1.0 10^{-2}$
Np (cm/s)	13	$(-5.0 \pm 1.4) 10^{-3}$	$8.0 10^{-3}$

3. Conclusion

In the single photoelectron detection mode as used at the LLR station, the systematic errors introduced by the diode transit time and by the GLONASS satellite signature effect should not exceed 1 or 2 centimeters. The new value of the center of mass correction for the GLONASS satellite given by V.Vasiliev is much more satisfactory than the previous one. No mean systematic effect appears for the 8 GLONASS satellites during the IGEX-98 campaign. The observed systematic effect for the individual satellite could be interpreted in terms of mismodelling of non- gravitational forces.

4. References

- BARLIER F., C. BERGER, P. BONNEFOND, P. EXERTIER, O. LAURAN, J.F. MANGIN et J.M. TORRE, *Laser-based validation of GLONASS orbits by short-arc technique*, Journal of Geodesy, in press, 2001.
- BONNEFOND P., P. EXERTIER, P. SCHAEFFER, S. BRUINSMA, F. BARLIER, *Satellite altimetry from a short-arc technique : application to the Mediterranean*. Journal of Geophysical Research, 100, (C12) : 25365-25382.
- EANES R.J., R.S. NEREM, P.A.M. ABUSALI, W. BAMFORD, K. KEY, J.C. RIES, B.E. SCHUTZ, *GLONASS orbits determination at the Center for Space Research Austin Texas* (Internet adress : <http://ilrs.gsfc.nasa.gov/glonass.html>), 2000.
- INEICHEN D., M. ROTHACHER, T. SPRINGER, G. BEUTLER, *Computation of precise GLONASS orbits for IGEX-98*, International Association of Geodesy Symposia. Geodesy beyond 2000, the challenges of the first decade, Schwarz (ed.), Vol. 121 : 26-31.
- SAMAN E., *Le Laser Lune Millimétrique et nouvelles méthodes de datation optique*, Université de Nice Sophia-Antipolis, thèse, 1995.
- WILLIS P., G. BEUTLER, W. GURTNER, G. HEIN, R.E. NEILAN, C. NOLL, J. SLATER, *IGEX: International GLONASS Experiment-Scientific objectives and preparation*, 32nd COSPAR Scientific Assembly, Nagoya, Japan, Adv. in Space Research 23(4) : 659-663, 1998.